

LamiFIX®

Pat. Internat. 2023/25

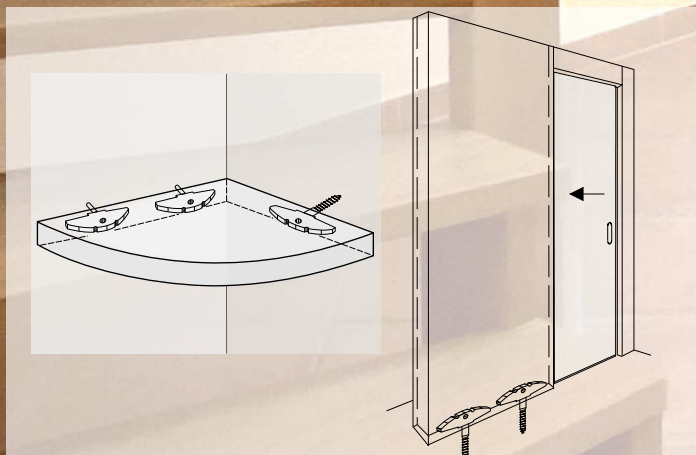

Beschläge für Möbel und Montagen
Ferrures pour meubles et montages
Fittings for furnitures and mountings

5 - 12

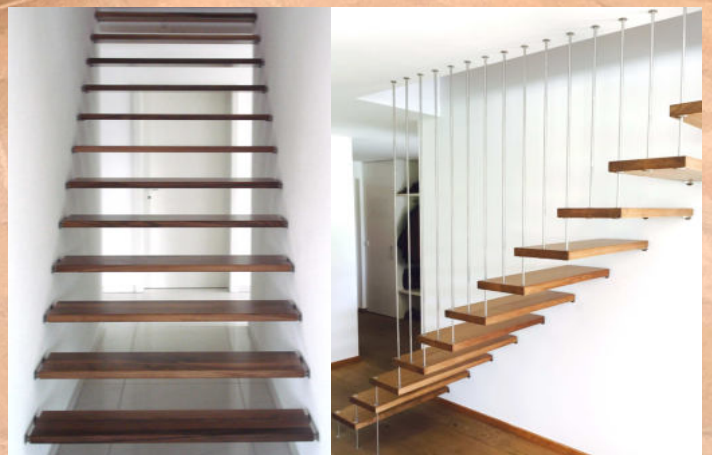





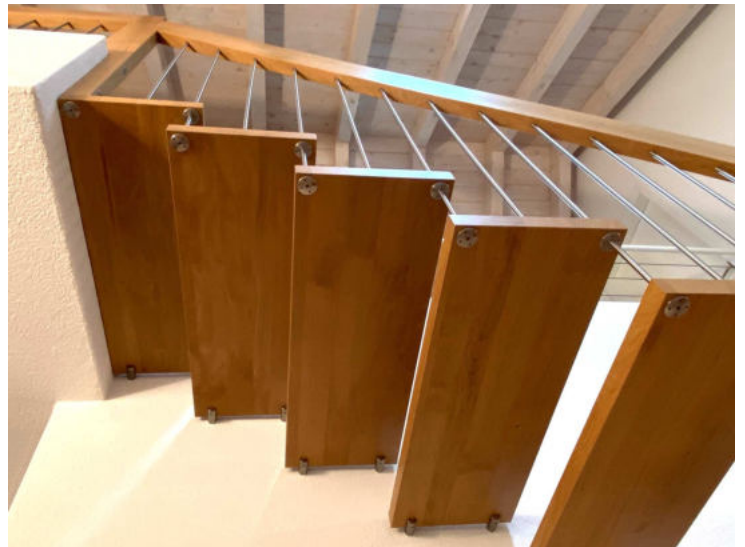

Beschläge für Treppen und Handläufe
Ferrures pour escaliers et mains courantes
Fittings for stairs and handrails

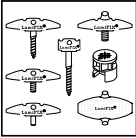
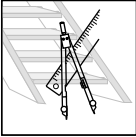
13 - 48

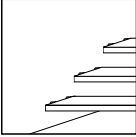
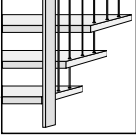
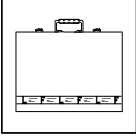
Treppenfotos:
Photos d'escaliers:
Stair photos:
www.lamifix.ch

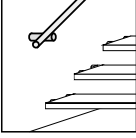

	<p>Inhaltsverzeichnis Sommaire Index</p>	<p>0</p>
	<p>Beschläge für Möbel + Montagen Ferrures pour meubles + montages Fittings for furnitures + mountings</p>	<p>1</p>
	<p>Technik + Statik für Treppen Technique + statique pour escaliers Technique + statics for stairs</p>	<p>2</p>
	<p>CAD-Planung, Plot 1:1 Planification CAO, plans 1:1 CAD-engineering, plots 1:1</p>	<p>3</p>
	<p>Stufenbefestigungen seitlich, Montageanleitung Fixations latérales des marches, instructions de montages Lateral step fixations, mounting instructions</p>	<p>4</p>
	<p>Stufenaufhängungen Ø10 + Ø16, Montageanleitungen, Zuschnittlisten, Pfostenverschraubung Suspensions des marches Ø10 + Ø16, instructions de montages, listes de coupe, vissage pour pilier Hanger for steps Ø10 + Ø16, mounting instructions, cutting lists, pile-screwing</p>	<p>5</p>
	<p>Montagekoffer für Treppen Coffret de montage pour escaliers Toolbox for stairs</p>	<p>6</p>
	<p>Antirutschbänder, Zentrumsschraube für Spindeltreppen Bande antidérapant, vis centrale pour escalier en colimaçon Anti-slip tape, center screw for spiral stairs</p>	<p>7</p>
	<p>Handlaufbeschläge Ferrures pour mains courantes Fittings for handrails</p>	<p>8</p>
	<p>Einzelteile + Diverses Pièces détachées + divers Single items + miscellaneous etc.</p>	<p>9</p>

Inhaltsverzeichnis A - Z

Abdeckhülsen - kappen	8 / 43 / 45
Anker	20-23 / 46
Anreisser	11
Antirutschband	40 / 48
Aufhängung	28-38
Avor-Listen	30 / 35
Bodenträger	7
Bohrbüchsen	11 / 27 / 45
Bohrer	11 / 27 / 38 / 44
Bohrschablonen	10 / 27 / 45
Bolzen	17-25 / 46
Bundmutter	37 / 47
CAD-Planung	15
Dämpfungshülsen -ringe	32 / 47
Deckrosetten	28-34 / 47-48
Distanzringe	24-45 / 45
Doppelverbinder	6
Eindrehwerkzeug	11 / 43 / 45
Einschlagtopf	45
Endrosetten	28 / 32 / 46
Endschrauben	11
Euroverbinder	7
Exzenter	8
Fachbodenträger	7
Gehrungsverbinder	6
Geländerstäbe	28-35 / 46-47
Gewindemuffen	11 / 28-32
Gewindestangen -stifte	32-35 / 44
Glaspunkthalter	25 / 48
Handlaufstützen	41 / 48
Innengewindehülsen	11 / 44
Inox-Rohre-Stangen	28-35 / 46-47
Justierscheiben	20-23 / 45
Koffer mit Grundsoriment	12
Koffer für den Treppenaufbau	39
Lamellenverbinder	5-12 / 17-24 / 43
Markierspitzen	11
Metrische Verbinder	7 / 9 / 43
Möbelverbinder	5-12
Montageanleitungen	26 / 29 / 33
Montagekoffer	12 / 39
Montageverbinder	5-12 / 17-25
Mörtel	44
Nutfräser	27 / 45
O-Ringe	32 / 47
Rohre INOX	32-35 / 46
Rosetten	19-37 / 44-48
Rundmutter	37 / 47
Rundstäbe	45
Schablonen	10 / 27 / 45
Schallschutzdübel	21-23 / 44
Schraubensicherung mittelfest	47
Siebhülsen	20 / 23 / 44
Stahlwängenelemente	24
Staketenbohrlehre	38 / 48
Staketenrohre	32 / 35 / 46
Stangen Inox geschliffen	28 / 47
Statik	13
Stirnlochschlüssel	38 / 47
Stockschrauben + Eindreher	38 / 43
Stufenaufhängungen	28-38
Stufenbohrer	38 / 44
Tablarträger	7
Topf zum Einschlagen	45
Tragrosetten	28-32 / 46 / 48
Treppenschrauben	37 / 47
Treppenbolzen	17-25 / 45-46
Treppenkoffer	39
Wandanschlussrosetten	19-23 / 44
Zentrumsschraube f. Spindelstiege	40
Zuschneiden auf Mass	30 / 35

Sommaire A - Z

Ancre	20-23 / 46
Anneau de distance	24-45 / 45
Antidérapant	40 / 48
Assortiment de base	5-12
Assortiment pour escalier	13-48
Bande antidérapante adhésive	40 / 48
Barre et tube pour balustrade	28-35 / 46-47
Barre ronde, Inox A2	28 / 45 / 47
Boulon	17-25 / 46
Canon de perçage	11 / 27 / 45
Capuchon	8 / 43 / 45
Cheville acoustique	21-23 / 44
Clé à ergots	38 / 47
Coffret de montage	12 / 39
Coffret pour escaliers	39
Connecteur avec lamelle	5-12 / 17-24 / 43
Douille de guidage	11 / 27 / 45
Douille de passoire	20 / 23 / 44
Douille de perçage	11 / 27 / 45
Douille en bois	28 / 31 / 47
Douille pour enforcer	45
Ecrou rond	37 / 47
Élément d'ajustage	20-23 / 45
Élément d'assemblage	5-12 / 17-25
Élément d'assembl. métrique	7 / 9 / 43
Élém. d'assembl. p. meuble	5-12
Élém. d'assembl. p. montages	5-12 / 17-25
Élément d'assembl. vis bois	5 / 9 / 12
Élément d'assembl. vis euro	7
Élément de suspension	28-38
Éléments pour limon en acier	24
Excentrique	8
Frain filet	47
Fraises à rainurer	27 / 45
Gabarit de perçage	10 / 27 / 45
Gabarit de perçage p. douilles	10
Gabarit de perçage p. suspension	38 / 48
Instructions des montages	26 / 29 / 33
Liste pour coupes	30 / 35
Manchon à visser	11 / 28-32
Manchon nylon	11
Mèche	11 / 27 / 38 / 44
Mortier chimique	44
Outil à visser	11 / 43 / 45
Outil pour réglage de DMC	10
Outil pour vis à deux filetages	38 / 43
Pattes à vis	5 / 12
Plan CAO	15
Pointe pour marquer	11
Porte-verre	25
Pot pour enforcer	45
Rallonge pour mèche	38 / 44
Rondelle de réglage distance	20-23 / 45
Rondelle isolante	32 / 47
Rosace du haut	28-34 / 47-48
Rosace portante	28-32 / 46 / 48
Rosace pour visser	27 / 45
Rosace terminale	28 / 32 / 46
Rosaces	19-37 / 44-48
Support de rayon	7
Support mains courantes	41 / 48
Suspension des marches	28-38
Statique	15
Tiges filetées	32-35 / 44
Tube	32-35 / 46
Vis	11 / 47 / 43-44
Vis avec deux filetages	38 / 43
Vis centrale pour escalier en colimaçon	40
Vis finales	11
Vis pour fixation sur verre	25 / 48
Vis p. pilier main courante	36 / 48

Index A - Z

Anchor	20-23 / 46
Anti-slip tape	40 / 48
Assortment for staircases	15-48
Balustrade tubes / bars	28-35 / 46-47
Bar Inox A2	28 / 47
Basic assortment	5-12
Bolt	17-25 / 46
CAD-planning	15
Cap nut	37 / 47
Center screw for spiral stairs	40
Chemical-mortar	44
Components for hanger	28-35
Connector with biscuit	5-12 / 17-24
Cover sleeve	45
Cutter for grooving	27 / 45
Distance ring	24-45 / 45
Drill	11 / 27 / 38 / 44
Drill guide	10 / 27 / 45
Drill jig	11 / 27 / 45
Drill jig for hanger	38 / 48
Eccentric cam	8
Elements for steel stringer	24
End bearing	28 / 32 / 46
Extension piece for drill	38 / 44
Face spanner for bearings	38 / 47
Fastener in steel stringer	24
Fixing element for furniture	5-12
Fixing element for mounting	5-12 / 17-25
Fixing elements, euro screw	7
Fixing elements, metric screw	7 / 9 / 43
Fixing elements, wood screw	5 / 9 / 12
Guide bush for drill guide	11 / 27 / 45
Glass holder	25 / 48
Hanger bolt	37 / 43
Hanger for steps	28-38
Height compensation	32 / 47
Inox bar	28 / 47
Inox tube	32-35 / 46
List for cutting	30 / 35
Marking-tip	11
Mortar in cartridge	44
Mounting anchor	20-23 / 46
Mounting instructions	26 / 29 / 33
Normes	13-14
O-ring	32 / 47
Pile screwing for handrails	41 / 48
Pot to hammer in	11 / 45
Ring cover top	28-32 / 47
Rosettes	19-37 / 44-48
Round bar	28 / 45
Screen tube	20 / 23 / 44
Screw	11 / 47 / 43-44
Screw for fastening at glass	25 / 48
Set for staircases	17-36
Shelf support	7
Silencer bush	32 / 47
Silencer dowel	21-23 / 44
Silencer ring	32 / 47
Spiral stair center screw	40
Support for handrails	41 / 48
Suspension	28-35
Statics	13
Steel stringer fastener	11 / 28
Steel thread sleeve	11 / 28-32
Tape anti-slip	40 / 48
Threadlocker	47
Thread sleeve	11 / 44
Threaded rods	32-35 / 44
Tool box for mounting	12 / 39
Tool box for staircases	39
Tube Inox A2	32 / 35 / 46

Bestellung Commande Order

Kunde, Client, Customer: _____

Kom., Commission: _____

Händler, Distributeur, Dealer: _____

www.lamifix.ch

lamifix@lamifix.ch

Tel: +41 55 225 48 48



2023/25

Anwendungen Applications Applications

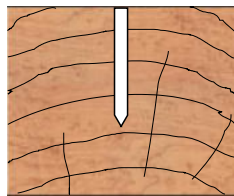
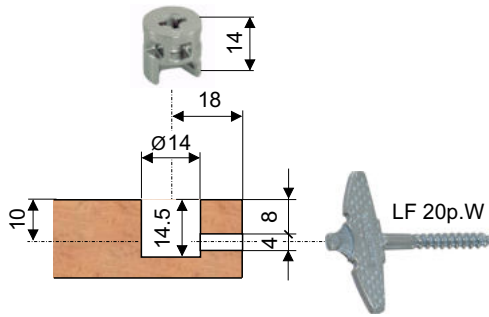
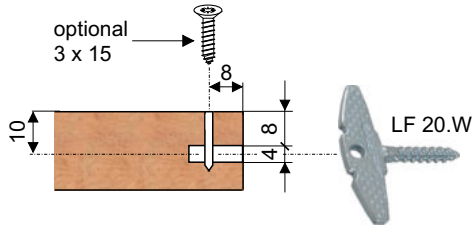

Holz, Bois, Wood

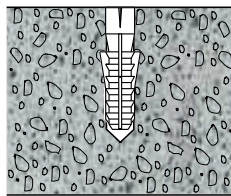

Beton, Béton, Concrete

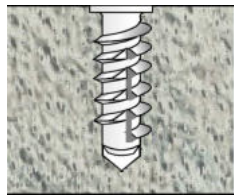

Porenbeton, Béton poreux Gas concrete



Gipskarton / -faserplatte Placoplâtre / fibroplâtre Gypsboard / Fiberboard

Fräsen Fraiseage Grooving

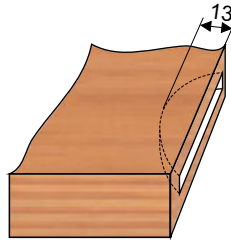

Eindreihen Visser Screwing



Art.			Code			Bestellung Commande Order
LF 20s.W5x38		20 x 12 x 4	5 x 38	1020.001.1	50	95.00
				1020.001.6 *	250	457.50
LF 20.W5x25		45 x 12 x 4	5 x 25	1020.003.1	50	92.50
				1020.003.6 *	250	450.00
LF 20.W5x38		45 x 12 x 4	5 x 38	1020.004.1	50	94.50
				1020.004.6 *	250	460.00
LF 20p.W5x38		45 x 18 x 4	5 x 38	1020.024.4	25	57.00
				1020.024.6 *	200	440.00

* inkl. 2 Stk./ pc. LF 220_MT
Markierspitze/Pointe de marquage/Marking-tip

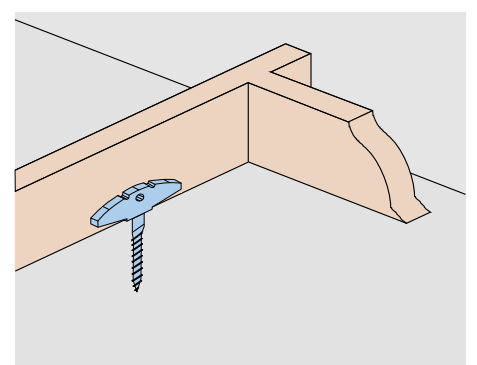
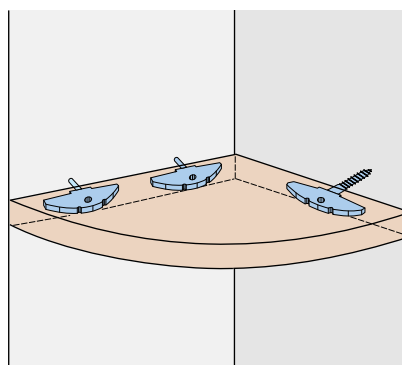
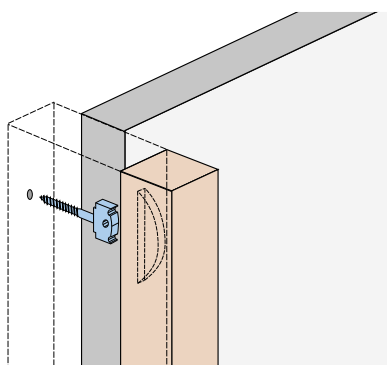

1

Bestellung Commande Order

Kunde, Client, Customer: _____

Kom., Commission: _____

Händler, Distributeur, Dealer: _____



www.lamifix.ch

lamifix@lamifix.ch

Tel: +41 55 225 48 48

2023/25

Anwendungen Applications



Fräsen Fraisage Grooving

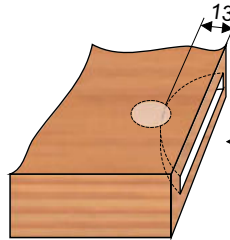
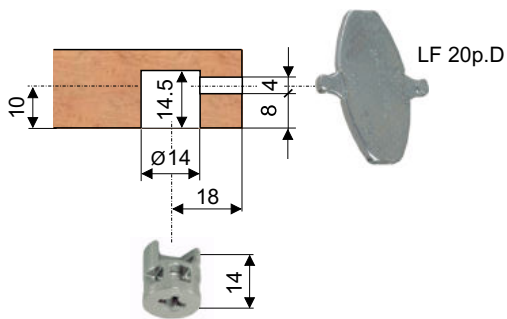

Art.



Code



Bestellung
Commande
Order

LF 20p.D

50 x 36 x 4

1020.044.1

25

33.50



1020.044.6

250

299.00

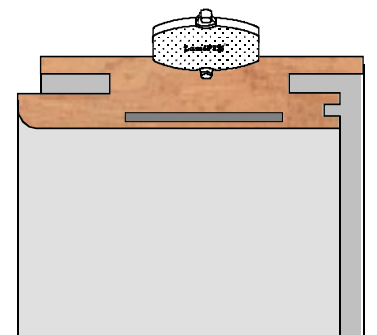
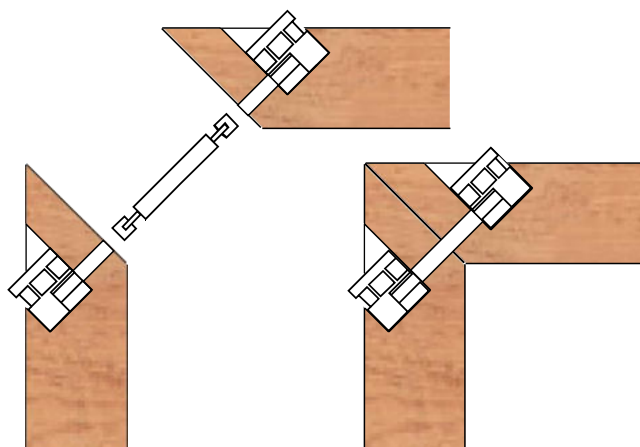
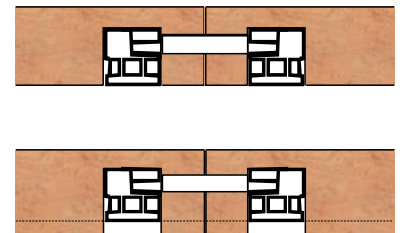
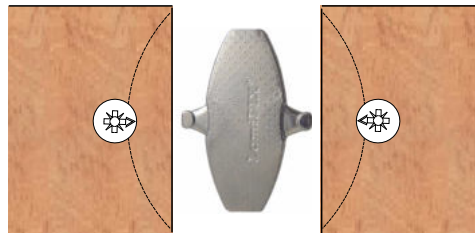

Bestellung Commande Order

Kunde, Client, Customer: _____

Kom., Commission: _____

Händler, Distributeur, Dealer: _____

www.lamifix.ch

lamifix@lamifix.ch

Tel: +41 55 225 48 48



2023/25

Anwendungen Applications Applications

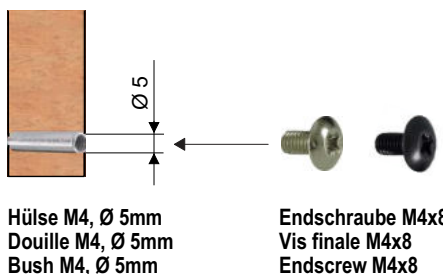
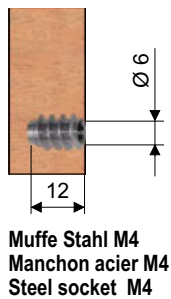
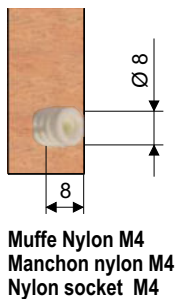
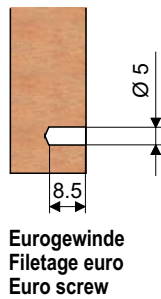
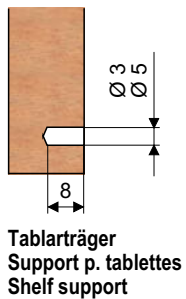
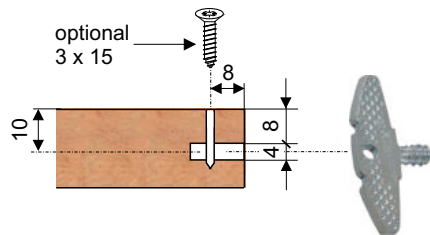
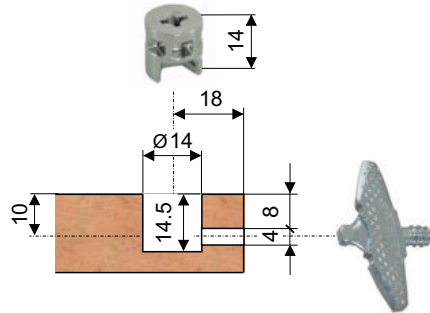

Fräsen Fraiseage Grooving

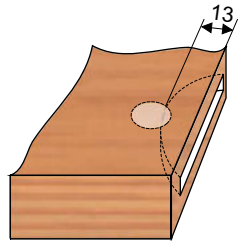

Eindreihen Visser Screwing



Art.			Code		CHF	Bestellung Commande Order	
LF 20.E6.3x8.5			45 x 12 x 4	6.3 x 8.5	1020.006.1	50	64.50
					1020.006.6 *	250	310.00
LF 20.M4x7.5			45 x 12 x 4	M4 x 7.5	1020.008.1	50	65.00
					1020.008.6 *	250	312.50
LF 20.T3x8			45 x 12 x 4	Ø 3 x 8	1020.010.1	50	63.00
					1020.010.6 *	250	300.00
LF 20.T5x8			45 x 12 x 4	Ø 5 x 8	1020.012.1	50	63.00
					1020.012.6 *	250	300.00
LF 20p.E6.3x8.5			45 x 18 x 4	6.3 x 8.5	1020.026.4	25	39.00
					1020.026.6 *	200	290.00
LF 20p.M4x7.5			45 x 18 x 4	M4 x 7.5	1020.028.4	25	39.00
					1020.028.6 *	200	290.00

* inkl. 2 Stk./pc. LF 220_MT
Markierspitze/Pointe de marquage/Marking-tip

Bestellung Commande Order

Kunde, Client, Customer: _____

Kom., Commission: _____

Händler, Distributeur, Dealer: _____

www.lamifix.ch

lamifix@lamifix.ch









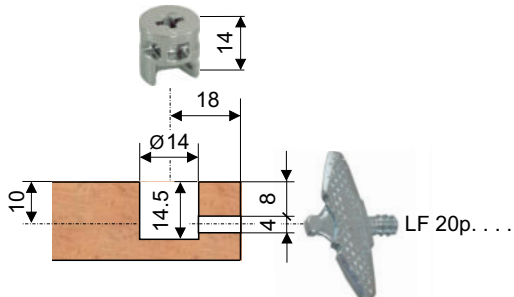

Tel: +41 55 225 48 48

















2023/25

Anwendungen Applications



Art.		Code			Bestellung Commande Order 
LF 114p.		Ø 14	1114.021.1	50	19.50 
			1114.021.6	250	94.00 
		Ohne Rand, Sans bord, Without border			
LF 114p.C		Ø 14 / 16	1114.022.1	50	19.00 
			1114.022.6	250	90.00 
		Mit Rand, Avec bord, With border			



LF 414.01	RAL 9010	Ø 18	1414.001.1	100	6.60 
			1414.001.2	1'000	60.00 
		Weiss, Blanc, White			
LF 414.02	RAL 9011	Ø 18	1414.002.1	100	6.60 
			1414.002.2	1'000	60.00 
		Schwarz, Noir, Black			
LF 414.03	RAL 1014	Ø 18	1414.003.1	100	6.60 
			1414.003.2	1'000	60.00 
		Kiefer, Pin, Pine			
LF 414.04	RAL 1011	Ø 18	1414.004.1	100	6.60 
			1414.004.2	1'000	60.00 
		Buche, Hêtre, Beech			
LF 414.05	RAL 8007	Ø 18	1414.005.1	100	6.60 
			1414.005.2	1'000	60.00 
		Braun, Marron, Brown			
LF 414.06	RAL 8014	Ø 18	1414.006.1	100	6.60 
			1414.006.2	1'000	60.00 
		Dunkelbraun, Brun foncé, Dark brown			
LF 414.07	RAL 8016	Ø 18	1414.007.1	100	6.60 
			1414.007.2	1'000	60.00 
		Mahagoni, Acajou, Mahogany			
LF 414.08	RAL 7035	Ø 18	1414.008.1	100	6.60 
			1414.008.2	1'000	60.00 
		Grau, Gris, Grey			

Bestellung Commande Order

Kunde, Client, Customer: _____

Kom., Commission: _____

Händler, Distributeur, Dealer: _____

www.lamifix.ch

lamifix@lamifix.ch

Tel: +41 55 225 48 48



2023/25

Top 20

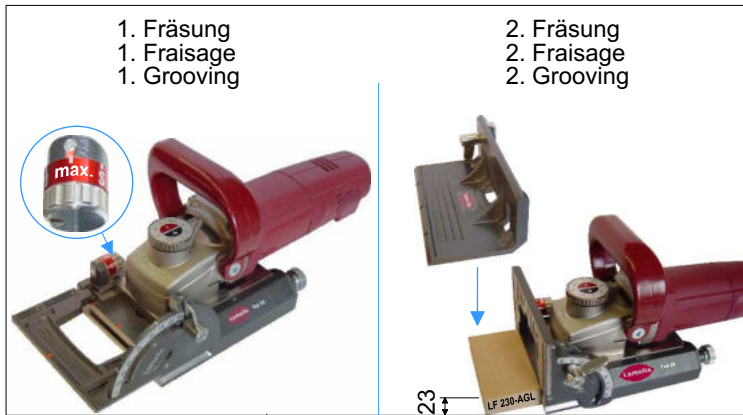

Optional: LF 30 = 12
LF 35 = 15

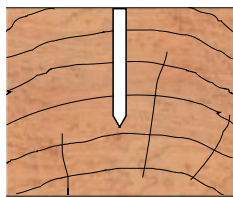
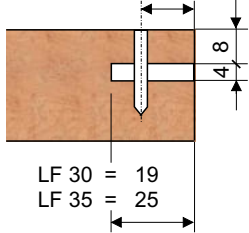

Holz, Bois, Wood

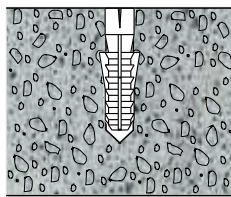

Beton, Béton, Concrete

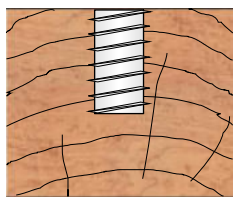

Holz, Bois, Wood

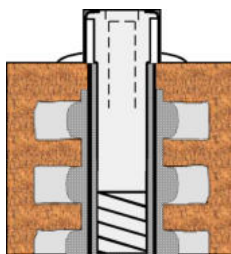

Ziegelstein, Brique, Brick

Zeta

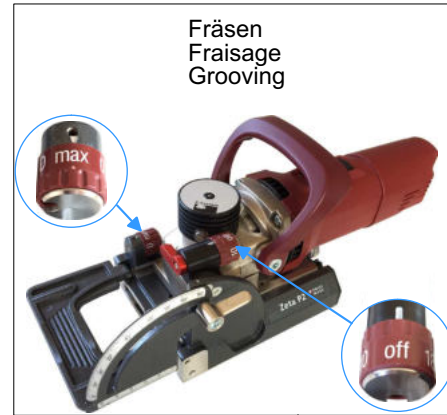

Art.			Code		CHF	Bestellung Commande Order
LF 30.W6.5x60	55 x 18 x 7	6.5 x 60	1030.001.1	25	74.50	
			1030.001.2	200	565.00	

LF 35.M10x30	35 x 22 x 7	M10 x 30	1035.130.1	25	99.50	
			1035.130.2	200	785.00	

LF 2199.105.3	Ø 105 / 30, HW	2199.105.3	1	275.00	
Fräser für Nute 7 x 25mm		Optional			
Fraise à rainurer		En option			
Cutter for grooving		Optional			

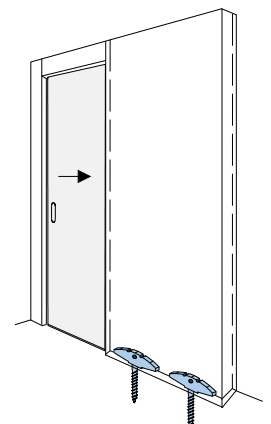
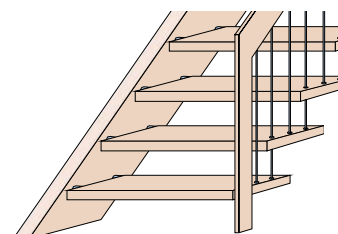
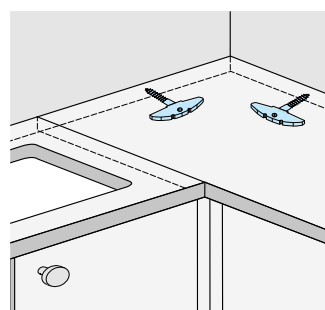
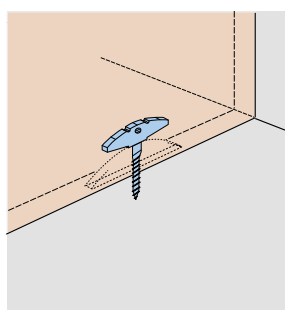

Eindreihen Visser Screwing



Bestellung Commande Order

Kunde, Client, Customer: _____

Kom., Commission: _____

Händler, Distributeur, Dealer: _____

www.lamifix.ch

lamifix@lamifix.ch

Tel: +41 55 225 48 48



2023/25

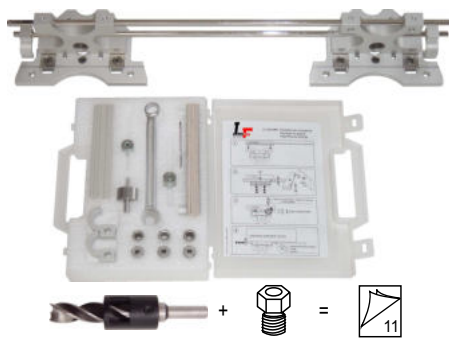
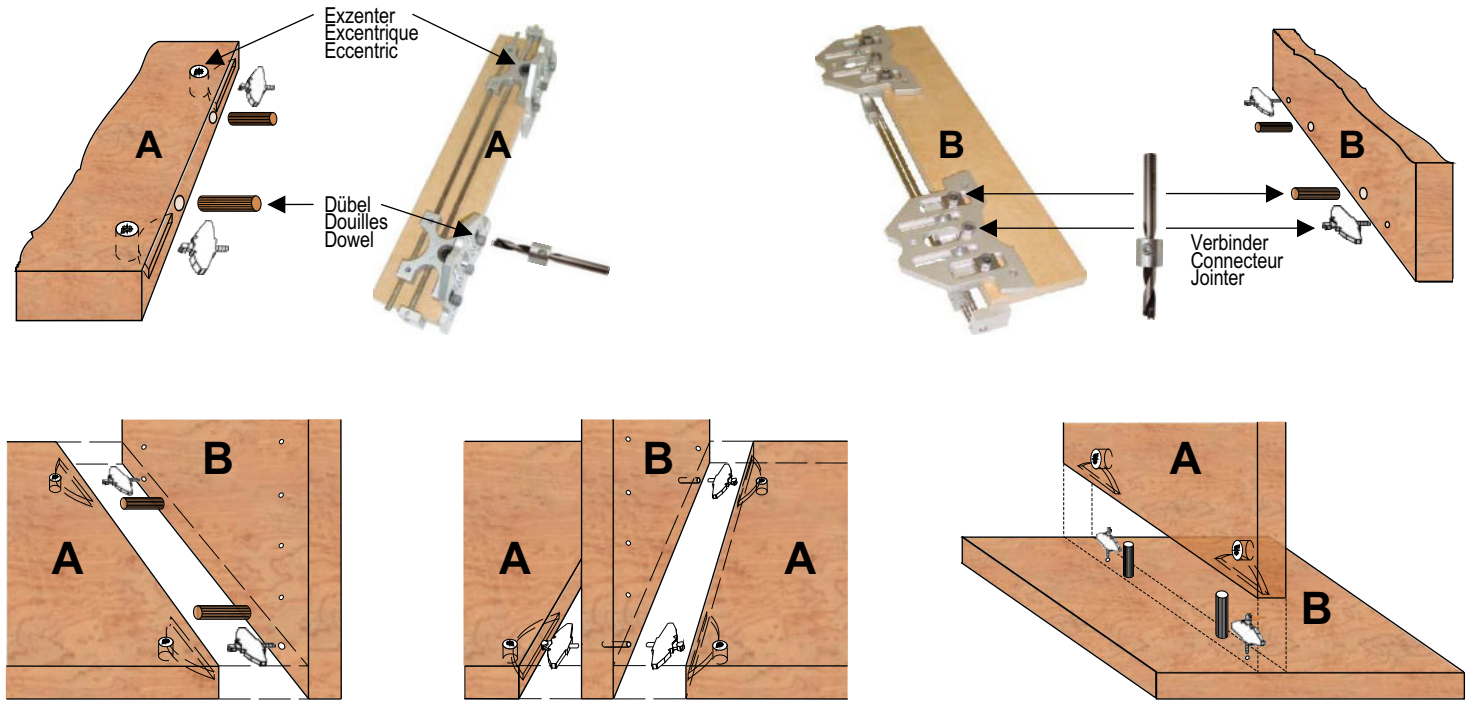

Art.	Code	📦	CHF	Stk./pcs
LF 220.DMC-1	2220.001.5	1 Stk. pcs	250.00	
LF 220.DMC-2	2220.002.5	Set = 2 Stk. pcs Inkl. Werkzeug, Outils incl., Incl. tools	515.00	
LF 220.DMC-3	2220.003.5	Set = 3 Stk. pcs Inkl. Werkzeug, Outils incl., Incl. tools	750.00	
LF 220.ES-2	2140.001.4	Endanschlag 2 Stk. pcs Butée finale, End stop	20.00	

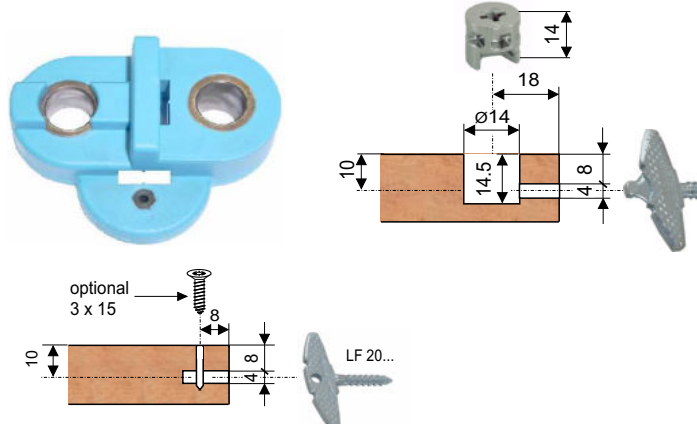
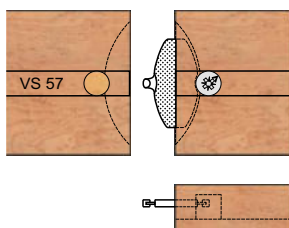

Im Montagekoffer enthalten
Inclus dans le coffret de montage
Included in tool box

Art.	Code	📦	CHF	Stk./pcs
LF 220.DMU	2220.040.3	1 Stk. pcs	55.00	

Bestellung Commande Order

Kunde, Client, Customer: _____

Kom., Commission: _____

Händler, Distributeur, Dealer: _____



www.lamifix.ch

lamifix@lamifix.ch

Tel: +41 55 225 48 48

2023/25

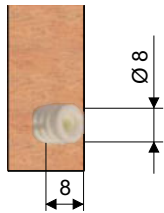

Muffe Nylon M4
Manchon nylon M4
Nylon socket M4

Art.	Code				Bestellung Commande Order
LF 420.M4	1440.001.1	Ø 8.0 x 8	100	7.50	
	1440.001.2		1'000	68.00	

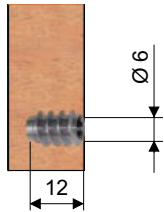

Muffe Stahl M4
Manchon acier M4
Steel socket M4

LF 1441.001	1441.001.1	Ø 6.0 x 12	100	33.00	
	1441.001.2		1'000	298.00	

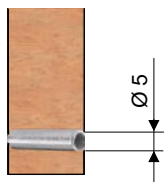

Hülse Stahl verzinkt, M4
Douille acier zingué, M4
Bush galvanized, M4

LF 440.15	1450.150.1	Ø 5.0 x 15 mm	100	11.00	
	1450.150.2		1'000	99.00	
LF 440.18	1450.180.1	Ø 5.0 x 18 mm	100	12.00	
	1450.180.2		1'000	109.00	
LF 440.22	1450.220.1	Ø 5.0 x 22 mm	100	13.00	
	1450.220.2		1'000	119.00	



Endschraube M4x8
Vis finale M4x8
Endscrew M4x8

LF 441.Ni	1460.001.1	vernickelt, nickelé	100	9.10	
	1460.001.2	nickled	1'000	85.50	
LF 441.02	1460.002.1	dunkel, foncé	100	9.40	
	1460.002.2	dark	1'000	88.30	



inkl. Tiefenanschlag
incl. butée de profondeur
incl. depth collar

LF 2031.025	2031.025.3	Ø 2.5, HS	1	5.70	
LF 2041.050*	2041.050.3	Ø 5.0, HW*	1	43.00	
LF 2041.080*	2041.080.3	Ø 8.0, HW*	1	47.00	



inkl. Tiefenanschlag
incl. butée de profondeur
incl. depth collar

LF 2031.140	2031.140.3	Ø 14.0, HS	1	48.00	
LF 2041.140*	2041.140.3	Ø 14.0, HW	1	73.50	

*HW In Bohrbüchsen ungeeignet / ne pas utiliser des canons de perçage / not for use in drill guides



Bohrbüchse
Canon de perçage
Drill guide

LF 205.DG	2110.050.3	Ø 5.0, gehärtet	1	12.50	
LF 206.DG	2110.060.3	Ø 6.0, trempé	1	12.50	
LF 208.DG	2110.080.3	Ø 8.0, hardened	1	12.50	



Markierspitze
Pointe de marquage
Marking-tip

LF 220_MT-4	2131.020.4	Set = 4 Stk. / pcs.	1	24.00	
-------------	------------	---------------------	---	-------	--



Eindrehwerkzeug LamiFIX
Outil à visser LamiFIX
Screwing tool LamiFIX

LF 2150.020	2150.020.3	→ LF 20...	1	42.00	
LF 230.BIT	2150.030.3	→ LF 30 + 35...	1	42.00	

1

Bestellung Commande Order

Kunde, Client, Customer: _____

Kom., Commission: _____

Händler, Distributeur, Dealer: _____

www.lamifix.ch

lamifix@lamifix.ch

Tel: +41 55 225 48 48



2023/25



Montagekoffer mit Lamellenverbinder
Coffret de montage avec l'assortiment de base
Tool box with basic assortment



LF 394.HIT

+



LF 220.DMC-2

Art.	Code	📦	CHF	Bestellung Commande Order
LF 394.HIT	3394.015.5	1 Stk. pcs	595.00	

Inkl. 200 Verbinder, 100 Exzenter, 7 Werkzeuge + 500 Zubehörteile
 Incl. 200 éléments d'assemblage, 100 excentriques, 7 outils + 500 accessoires
 Incl. 200 fixing elements, 100 eccentrics, 7 tools + 500 accessories

LF 395.HIT	3395.015.5	Set	1'080.00	
------------	------------	-----	----------	--

Komplette Grundausstattung
 Équipement de base complet
 Complete basic equipment

Wir danken der Hochschule für Technik in Rapperswil für ihre Zusammenarbeit, besonders Herrn Prof. Felix Wenk, dipl. Bauingenieur ETH / SIA / WTA / GfKORR, für statische Berechnungen und Normenteil, sowie Herrn Martin Egli, Fachstelle Baustoffprüfung, für die neuen Labortests.

Nous remercions l'Ecole Polytechnique de Rapperswil pour sa coopération, notamment M. Prof. Felix Wenk, ingénieur diplômé ETH / SIA / WTA / GfKORR pour les calculs de statique et pour la part des normes ainsi que M. Martin Egli, directeur de bureau de construction des matériaux d'essai pour les nouveaux tests en laboratoire.

We would like to thank the Institute of Technology in Rapperswil for its cooperation, especially Mr. Prof. Felix Wenk, graduated engineer ETH / SIA / WTA / GfKORR for the static calculations and for the standards part, as well as Mr. Martin Egli, director of construction materials testing for the new laboratory tests.

Grundlagen: EN 1995-1-1 : 2010-12 (Eurocode 5-1-1)
 Base: SIA 263 : 2013
 Basic: SIA 265 : 2012

Holzsortierungen / Qualität: EN 338
 Triage des bois / qualité: EN 1194
 Wood gradings / quality: SIA 265

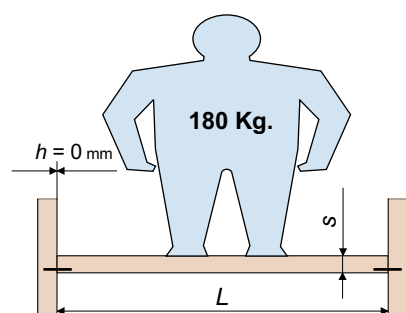

Stufenlänge Longueur des marches Step length	Hartholz D30 Bois dur D30 Hardwood D30 EN 338
L mm	s mm
900	36* - 40
1000	40* - 44
1100	40* - 44
1200	42* - 46

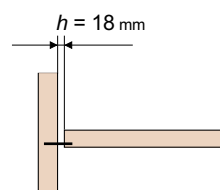

900	36* - 40
1000	40* - 44
1100	40* - 44
1200	42* - 46

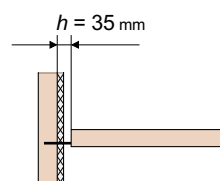

900	36* - 40
1000	40* - 44
1100	40* - 44
1200	42* - 46

* Statisch erforderlich.
 Données statiques indispensables.
 Static requirement.

DE Innentreppe

Podesttreppen:	In der Regel für alle Bauten geeignet.
Gerade Treppen:	Bei Mehrfamilienhäuser, Zwischenpodest vorsehen.
Gewendelte Treppen:	Mehrheitlich in Einfamilienhäuser.
Spindeltreppen:	Als Haupttreppen vermeiden.
Steiltreppen:	Auftritt wechselseitig, bedingt zulässig. Durchgang $\geq 500 - 700\text{mm}$, beidseitig Handläufe.

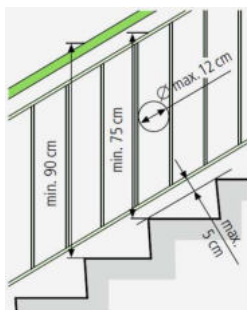

Sicherungen:	Öffnungen $\leq \varnothing 120\text{mm}$.
Zwischenpodeste:	Mindestens nach 18 Stufen.
Steigverhältnis:	$2 \times \downarrow + 1 \times \leftrightarrow = \sim 620 - 640\text{mm}$ (Gehlinienbereich).
Gehlinie:	Von der Innenseite, Spindeltreppen von der Aussenseite.
Auftritt:	Bei der Gehlinie $\sim 260 - 290\text{mm}$, beim Treppenauge $\sim 120\text{mm}$.
Durchgangsbreite:	In Einfamilienhäuser $\geq 900\text{mm}$, im Mehrfamilienhäuser $\geq 1200\text{mm}$.
Wandabstand:	Stufen und Podeste $\leq 50\text{mm}$, Handläufe $\geq 50\text{mm}$.
Absturzsicherung:	Geländer und Brüstungen $\geq 1000\text{mm}$. Im Treppenlauf $\geq 900\text{mm}$.
Wand-Handläufe:	Stufen Vorderkante - Handlauf Oberkante $\downarrow 850 - 900\text{mm}$. $\varnothing 35 - 45\text{mm}$.

FR Escaliers intérieurs

Escaliers avec palier:	Convient pour tous les bâtiments.
Escaliers droits:	Pour immeubles publiques; prévoir des paliers.
Escaliers tournants:	Convenant pour les maisons individuelles.
Escaliers à colimaçon:	Déconseillé pour escaliers principaux.
Escaliers de meunier:	Marche alternante, admission limitée, passage $\geq 500 - 700\text{mm}$, mains courantes des deux côtés.

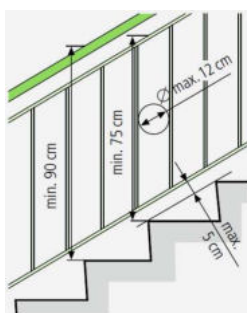

Garde corps:	Ouverture $\leq \varnothing 120\text{mm}$.
Palier:	Au moins après 18 marches.
Rapport inclinaison:	$2 \times \downarrow + 1 \times \leftrightarrow = \sim 620 - 640\text{mm}$ (ligne de foulée).
Ligne de foulée:	Du côté intérieur; escaliers tournants du côté extérieur.
Giron:	Sur la ligne de foulée $\sim 260 - 290\text{mm}$. Près de la lunette $\sim 120\text{mm}$.
Emmarchement:	Dans les maisons individuelles $\geq 900\text{mm}$. Dans les immeubles publiques $\geq 1200\text{mm}$.
Distance du mur:	Marches et estrades $\leq 50\text{mm}$, mains courantes $\geq 50\text{mm}$.
Hauteur de balustrade:	Pour escaliers et garde corps $\geq 1000\text{mm}$. La volée d'escalier $\geq 900\text{mm}$.
Mains courantes:	Nez de marche - bord supérieur main courante $\downarrow 850 - 900\text{mm}$. $\varnothing 35 - 45\text{mm}$.

EN Indoor stairs

Pedestals stairs:	In general, suitable for all buildings.
Straight stairs:	By apartment buildings; consider half-pace.
Helical stairs:	Mostly in one-family houses.
Spiral stairs:	Unapt for main stairs.
Steep stairs:	Alternately step, limited admission, alley $\geq 500 - 700\text{mm}$, handrails on both sides.

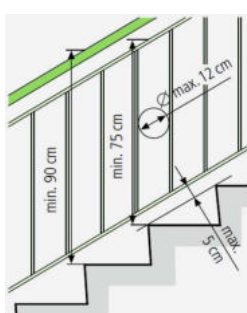

Safety:	Opening $\leq \varnothing 120\text{mm}$.
Half-pace:	After 18 steps at least.
Raising proportion:	$2 \times \downarrow + 1 \times \leftrightarrow = \sim 620 - 640\text{mm}$ (walk line area).
Walk line:	From the interior; spiral stairs from the exterior.
Step depth:	At the walk line $\sim 260 - 290\text{mm}$. At the inner well side string $\sim 120\text{mm}$.
Passage width:	In one-family houses $\geq 900\text{mm}$, in apartment buildings $\geq 1200\text{mm}$.
Wall distance:	Steps and half-paces $\leq 50\text{mm}$, handrails $\geq 50\text{mm}$.
Balustrade height:	For stairs and balustrades $\geq 1000\text{mm}$. At the stairway $\geq 900\text{mm}$.
Handrails:	Step leading edge - handrail upper edge $\downarrow 850 - 900\text{mm}$. $\varnothing 35 - 45\text{mm}$.

Bestellung Commande Order

Kunde, Client, Customer: _____

Kom., Commission: _____

Händler, Distributeur, Dealer: _____



www.lamifix.ch

lamifix@lamifix.ch

Tel: +41 55 225 48 48

2023/25

CAD-Planung, Plot 1:1
Planification CAO, plans 1:1
CAD-engineering, plots 1:1



1) Panung A4: Grundriss + Seitenansicht (Perspektive)
 2) Plot 1:1 oder DXF mit Detail: Wangen, Stufen + Handlauf
 3) Stücklisten für: Holz + Beschläge

1) Projet A4: Plan horizontal + vue de côté
 2) Plot 1:1 ou DXF en détail: Limons, marches + mains courantes
 3) Liste des pièces pour: Bois + ferrures

1) Layout A4: Ground plan + side view
 2) Plot 1:1 or DXF with details: Stringboards, steps + handrails
 3) Part lists for: Wood + fittings

CHF~

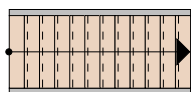

Gerade Treppe
Escalier droit
Straight stair

1) Planung, Projet, Layout 150.00
 2) Plot / DXF 200.00
 3) Stücklisten, Liste des pièces, Part lists 70.00

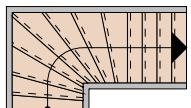

Treppe 1/4 gewunden
Escalier 1/4 tournant
Stair 1/4 helical

1) Planung, Projet, Layout 200.00
 2) Plot / DXF 200.00
 3) Stücklisten, Liste des pièces, Part lists 70.00

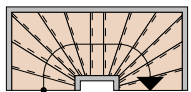

Treppe 2 x 1/4 gewunden
Escalier 2 x 1/4 tournant
Stair 2 x 1/4 helical

1) Planung, Projet, Layout 250.00
 2) Plot / DXF 200.00
 3) Stücklisten, Liste des pièces, Part lists 70.00

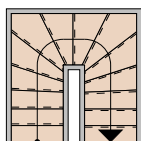

Treppe 1/2 gewunden
Escalier 1/2 tournant
Stair 1/2 helical

1) Planung, Projet, Layout 250.00
 2) Plot / DXF 200.00
 3) Stücklisten, Liste des pièces, Part lists 70.00

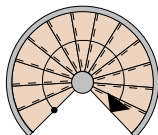

Spindeltreppe
Escalier à colimaçon
Spiral stair

1) Planung, Projet, Layout 250.00
 2) Plot / DXF 200.00
 3) Stücklisten, Liste des pièces, Part lists 70.00

Spezialtreppe
Escalier spécial
Special stair

nach Aufwand p/h 135.00
 selon frais p/h 135.00
 at cost p/h 135.00

Direkt bei:
Directement chez:
Directly by:

Ruedi Kälin
 Bremgartenstr. 10
 CH-5622 Waltenschwil

Tel +41 56 622 00 07
 Mob +41 79 312 92 88
 Email ruedikalin@gmail.com



1) _____
 2) _____
 3) _____

Trüssel Datentechnik AG
 Sonnmatte 6
 CH-6214 Schenkon LU

Tel +41 41 921 30 50
 Email info@truessel.org



1) _____
 2) _____
 3) _____

Mauron Fils SA
 Rte de Corserey 22
 CH-1746 Prez-vers-Noréaz

Tel +41 26 470 12 15
 Fax +41 26 470 11 46
 Email info@escaliers-mauron.ch



1) _____
 2) _____
 3) _____

Lieferfrist: ca. 1 Woche
 Délai de livraison: env. 1 semaine
 Term of delivery: ca. 1 week

3

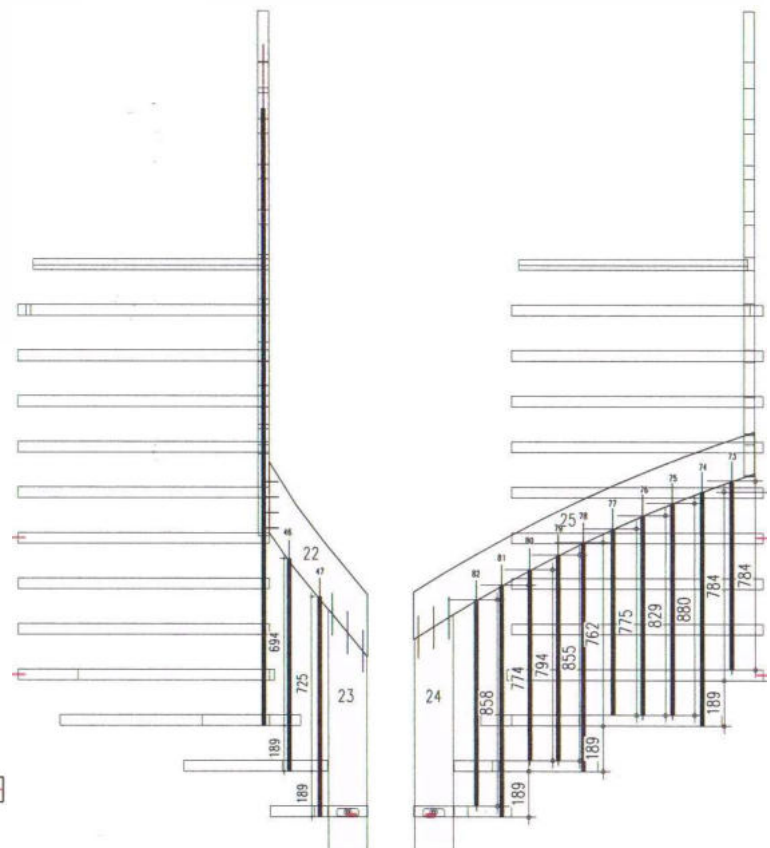
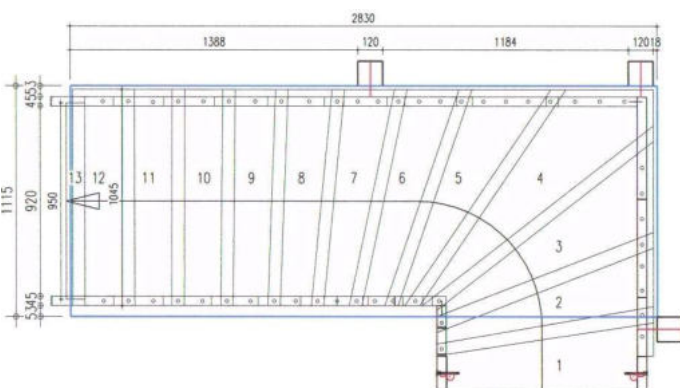
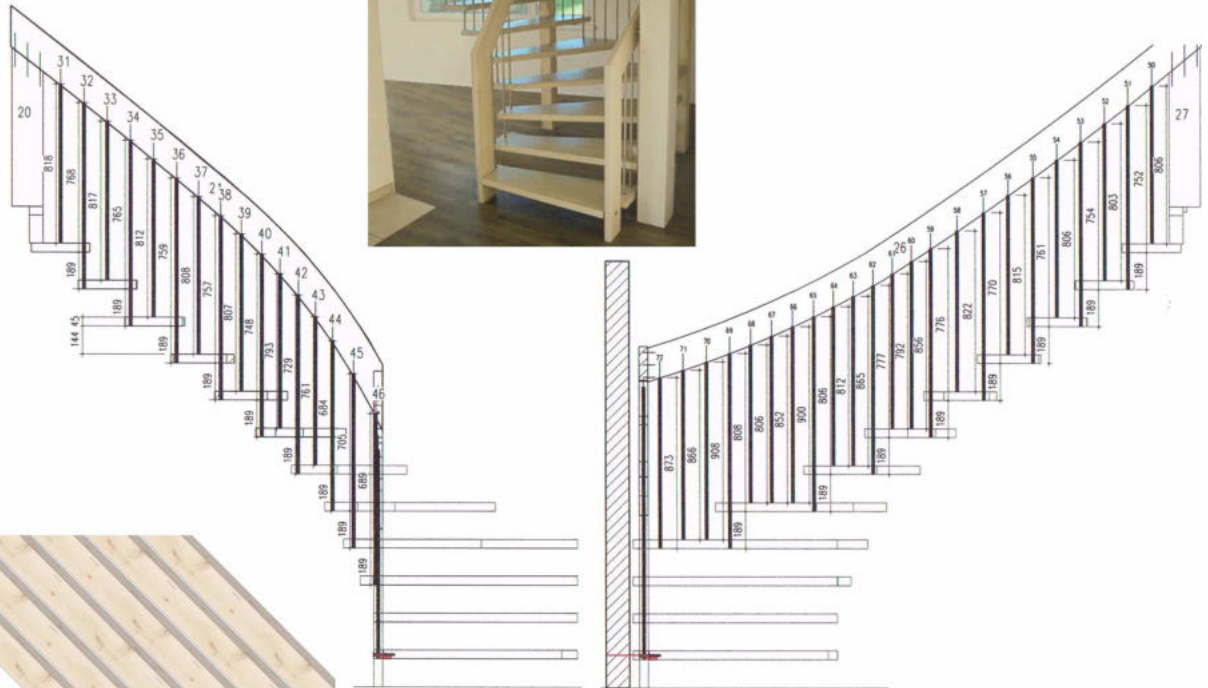

Bestellung Commande Order

Kunde, Client, Customer: _____

Kom., Commission: _____

Händler, Distributeur, Dealer: _____



www.lamifix.ch

lamifix@lamifix.ch

Tel: +41 55 225 48 48

2023/25

Holzrichtung-Faserverlauf Sens des fibres du bois Wood direction-fiber flow	T		
	mm	mm	mm
Hartholz Bois dur Hardwood D30, EN 338	35	35	35
Brettschichtholz Bois lamellé-collé Glued laminated wood EN 1194	50	50	65
Weichholz Bois tendre Softwood C24, EN 338	50	65	80

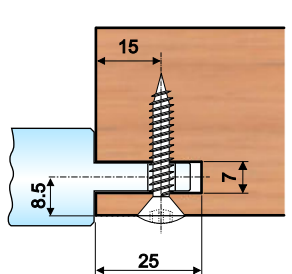
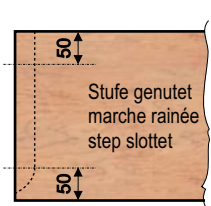
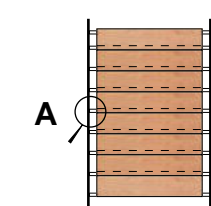
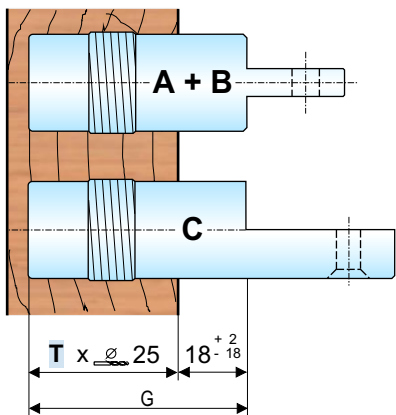

A

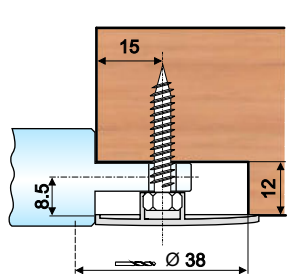
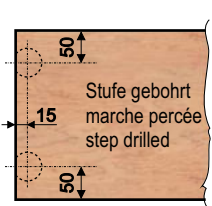
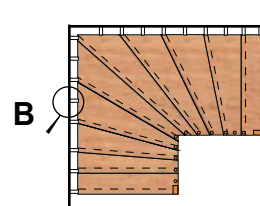

B

C = Schnellste Montage
Assemblage rapide
Fastest assembly

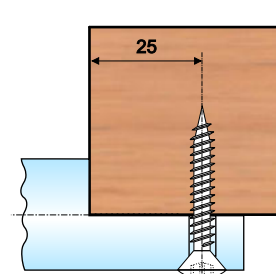
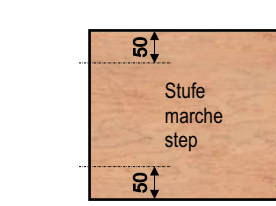

C

Set 1

	Art. / Code	CHF	Stk/pcs		Art. / Code	CHF	Stk/pcs		Art. / Code	CHF	Stk/pcs
Abdeckkappe, Capuchon, Cap					LF 1435.001	1.90	1		LF 1541.003	0.40	1*
Schraube, Vis, Screw	LF 1541.002	0.39	1*		LF 1560.003	0.29	1*		LF 3623.5...	11.00 - 14.45	1
Bolzen, Boulon, Bolt	LF 3623.0...	11.00 - 14.45	1		LF 3623.0...	11.00 - 14.45	1		LF 3625.001	0.10	1/50*
Waxilit, Lubrifiant, Lube	LF 3625.001	0.10	1/50*		LF 3625.001	0.10	1/50*				
T = 35mm G = 53mm	1 Set	LF 3623.135.4~	11.50		LF 3623.235.4~	13.30			LF 3623.535.4~	11.50	
≥100 Set		LF 3623.135.6	11.00		LF 3623.235.6	12.65			LF 3623.535.6	11.00	
T = 50mm G = 68mm	1 Set	LF 3623.150.4~	12.75		LF 3623.250.4~	14.55			LF 3623.550.4~	12.75	
≥100 Set		LF 3623.150.6	12.25		LF 3623.250.6	13.90			LF 3623.550.6	12.25	
T = 65mm G = 83mm	1 Set	LF 3623.165.4~	13.85		LF 3623.265.4~	15.70			LF 3623.565.4~	13.85	
≥100 Set		LF 3623.165.6	13.35		LF 3623.265.6	15.00			LF 3623.565.6	13.35	
T = 80mm G = 98mm	1 Set	LF 3623.180.4~	14.95		LF 3623.280.4~	16.75			LF 3623.580.4~	14.95	
≥100 Set		LF 3623.180.6	14.45		LF 3623.280.6	16.10			LF 3623.580.6	14.45	

Art. / Code	Détail	Stk*	CHF
LF 1541.002.1	A	100	39.00
LF 1541.003.1	C	100	39.90
LF 1560.003.1	B	100	29.00
LF 3625.001.1	A / B / C	1	4.95



Eindrehwerkzeug, Outil à visser, Screw tool	LF 2150.036.3	42.00	LF 2151.036.3	42.00
Holzspiralbohrer, Mèche pour bois, Drill for wood	LF 2001.250.3	Ø 25mm HS		95.00
Weitere Werkzeuge, plus d'outils, more tools				

Bestellung Commande Order

Kunde, Client, Customer: _____

Kom., Commission: _____

Händler, Distributeur, Dealer: _____



www.lamifix.ch

lamifix@lamifix.ch

Tel: +41 55 225 48 48

2023/25

Holzrichtung-Faserverlauf Sens des fibres du bois Wood direction-fiber flow	T		
	mm	mm	mm
Hartholz Bois dur Hardwood D30, EN 338	30	30	30
Brettschichtholz Bois lamellé-collé Glued laminated wood EN 1194	38	38	53
Weichholz Bois tendre Softwood C24, EN 338	38	53	68

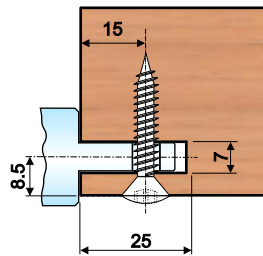
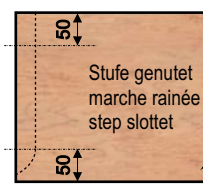
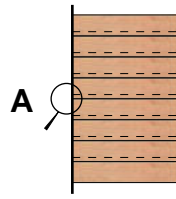
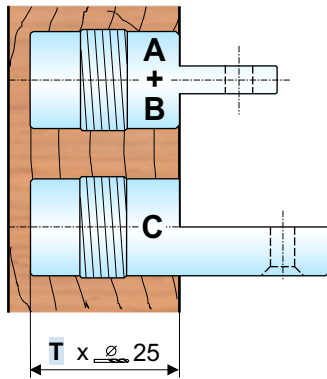

A

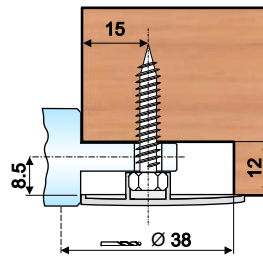
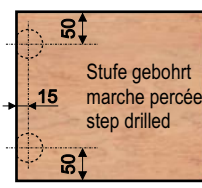
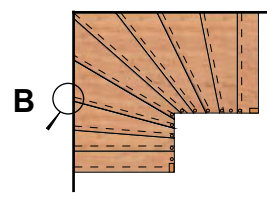

B

C = Schnellste Montage
Assemblage rapide
Fastest assembly

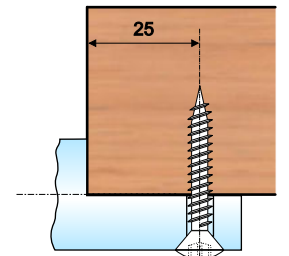
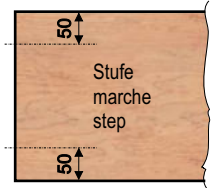

C

Set 3624

Abdeckkappe, Capuchon, Cap
Schraube, Vis, Screw
Bolzen, Boulon, Bolt
Waxilit, Lubrifiant, Lube

Art. / Code	CHF	STK/pcs	Art. / Code	CHF	STK/pcs	Art. / Code	CHF	STK/pcs
LF 1541.002	0.39	1*	LF 1435.001	1.90	1	LF 1541.003	0.40	1*
LF 3624.0	10.90 - 12.25	1	LF 1560.003	0.29	1*	LF 3624.5	10.90 - 12.25	1
LF 3625.001	0.10	1/50*	LF 3624.0	10.90 - 12.25	1	LF 3625.001	0.10	1/50*
T = 30mm			T = 30mm			T = 30mm		
1 Set	LF 3624.130.4~	11.40	1 Set	LF 3624.230.4~	13.20	1 Set	LF 3624.530.4~	11.40
≥100 Set	LF 3624.130.6	10.90	≥100 Set	LF 3624.230.6	12.55	≥100 Set	LF 3624.530.6	10.90
T = 38mm			T = 38mm			T = 38mm		
1 Set	LF 3624.138.4~	11.45	1 Set	LF 3624.238.4~	13.25	1 Set	LF 3624.538.4~	11.45
≥100 Set	LF 3624.138.6	10.95	≥100 Set	LF 3624.238.6	12.60	≥100 Set	LF 3624.538.6	10.95
T = 53mm			T = 53mm			T = 53mm		
1 Set	LF 3623.135.4~	11.50	1 Set	LF 3623.235.4~	13.30	1 Set	LF 3623.535.4~	11.50
≥100 Set	LF 3623.135.6	11.00	≥100 Set	LF 3623.235.6	12.65	≥100 Set	LF 3623.535.6	11.00
T = 68mm			T = 68mm			T = 68mm		
1 Set	LF 3623.150.4~	12.75	1 Set	LF 3623.250.4~	14.55	1 Set	LF 3623.550.4~	12.75
≥100 Set	LF 3623.150.6	12.25	≥100 Set	LF 3623.250.6	13.90	≥100 Set	LF 3623.550.6	12.25

Art. / Code	Détail	☒*	CHF
LF 1541.002.1	A	100	39.00
LF 1541.003.1	C	100	39.90
LF 1560.003.1	B	100	29.00
LF 3625.001.1	A / B / C	1	4.95



Eindrehwerkzeug, Outil à visser, Screw tool **LF 2150.036.3** 42.00 **LF 2151.036.3** 42.00

Holzspiralbohrer, Mèche pour bois, Drill for wood **LF 2001.250.3** Ø 25mm HS 95.00

Bestellung Commande Order

Kunde, Client, Customer: _____

Kom., Commission: _____

Händler, Distributeur, Dealer: _____



www.lamifix.ch

lamifix@lamifix.ch

Tel: +41 55 225 48 48

2023/25

Holzrichtung-Faserverlauf Sens des fibres du bois Wood direction-fiber flow	T		
	mm	mm	mm
Hartholz Bois dur Hardwood D30, EN 338	50	50	50
Weichholz Bois tendre Softwood C24, EN 338	65	80	80
Dreischichtplatte Bois à trois couches Three-layer wood board	65	65	65
OSB - Platte OSB - panneau OSB - board	65	65	65

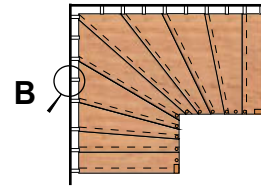
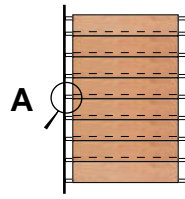

C = Schnellste Montage
Assemblage rapide
Fastest assembly

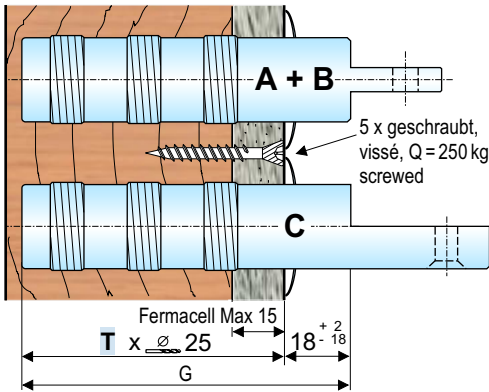
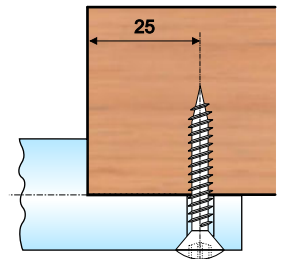
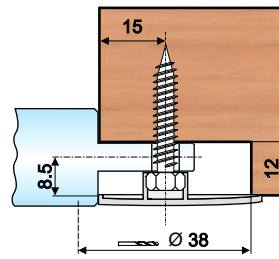
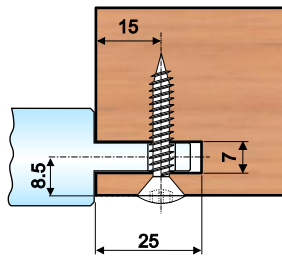
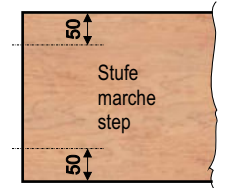
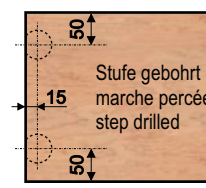
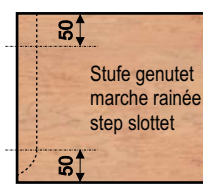

Set 2

	Art. / Code	CHF	Stk/pcs		Art. / Code	CHF	Stk/pcs		Art. / Code	CHF	Stk/pcs
Abdeckkappe, Capuchon, Cap					LF 1435.001	1.90	1		LF 1435.001	1.90	1
Schraube, Vis, Screw	LF 1530.006	0.62	5*		LF 1530.006	0.62	5*		LF 1530.006	0.62	5*
Schraube, Vis, Screw	LF 1541.002	0.39	1*		LF 1560.003	0.29	1*		LF 1541.003	0.40	1*
Rosette, Rosace	LF 1801.025	1.90	1		LF 1801.025	1.90	1		LF 1801.025	1.90	1
Bolzen, Boulon, Bolt	LF 3623.0	12.25 - 14.45	1		LF 3623.0	12.25 - 14.45	1		LF 3623.0	12.25 - 14.45	1
Waxilit, Lubrifiant, Lube	LF 3625.001	0.10	1/50*		LF 3625.001	0.10	1/50*		LF 3625.001	0.10	1/50*

T	G	Set	Art. / Code	CHF	Art. / Code	CHF	Art. / Code	CHF
50mm	68mm	1 Set	LF 3623.350.4~	15.25	LF 3623.450.4~	17.05	LF 3623.650.4~	15.25
		≥100 Set	LF 3623.350.6	14.60	LF 3623.450.6	16.25	LF 3623.650.6	14.60
65mm	83mm	1 Set	LF 3623.365.4~	16.35	LF 3623.465.4~	18.15	LF 3623.665.4~	16.35
		≥100 Set	LF 3623.365.6	15.70	LF 3623.465.6	17.35	LF 3623.665.6	15.70
80mm	98mm	1 Set	LF 3623.380.4~	17.45	LF 3623.480.4~	19.25	LF 3623.680.4~	17.45
		≥100 Set	LF 3623.380.6	16.80	LF 3623.480.6	18.45	LF 3623.680.6	16.80

Art. / Code	Détail	☒*	CHF
LF 1530.006.1	A / B / C	100	12.50
LF 1541.002.1	A	100	39.00
LF 1541.003.1	C	100	39.90
LF 1560.003.1	B	100	29.00
LF 3625.001.1	A / B / C	1	4.95



Eindrehwerkzeug, Outil à visser, Screw tool	LF 2150.036.3	42.00	LF 2151.036.3	42.00
Holzspiralbohrer, Mèche pour bois, Drill for wood	LF 2001.250.3	Ø 25mm HS		95.00
Weitere Werkzeuge, plus d'outils, more tools				44

Bestellung Commande Order

Kunde, Client, Customer: _____

Kom., Commission: _____

Händler, Distributeur, Dealer: _____



www.lamifix.ch

lamifix@lamifix.ch

Tel: +41 55 225 48 48

2023/25

In Ziegelstein / Beton, ohne Schallschutz
In brique / béton, sans isolation acoustique
In brick / concrete, without noise protection

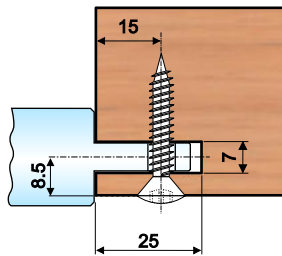
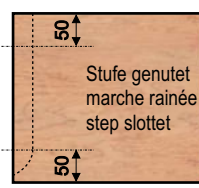
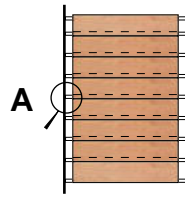
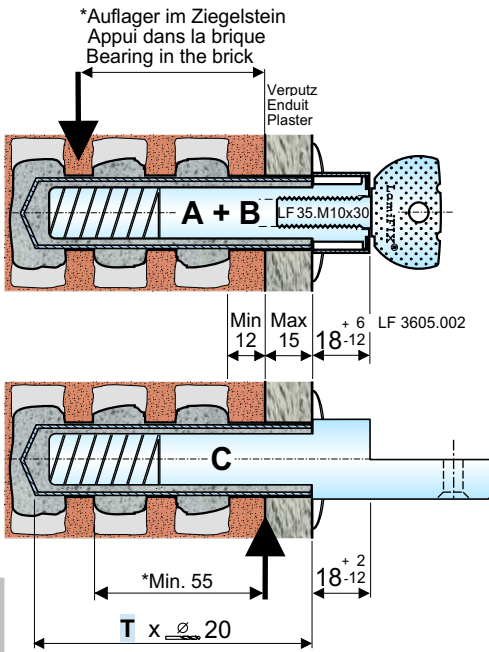

A

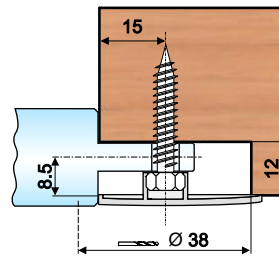
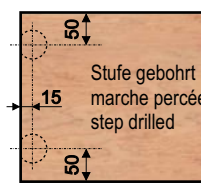
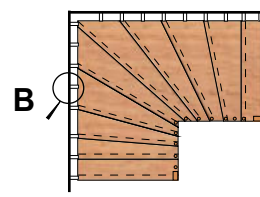

B

C = Schnellste Montage
Assemblage rapide
Fastest assembly

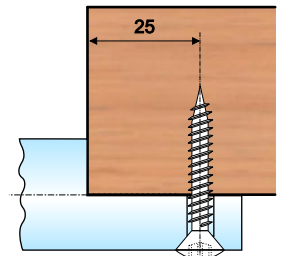
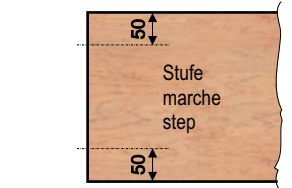

C

Set 5

	Art. / Code	CHF			Art. / Code	CHF			Art. / Code	CHF	
Verbinder, Raccord, Fixing	LF 1035.130	4.10	1		LF 1035.130	4.10	1		LF 1541.003	0.40	1*
Abdeckkappe Capuchon, Cap					LF 1435.001	1.90	1		LF 1710.020	1.50	1
Schraube, Vis, Screw	LF 1541.002	0.39	1*		LF 1560.003	0.29	1*		LF 1720.002	4.33	1/9*
Siebhülse, Douille de passoire, Screen tube	LF 1710.020	1.50	1		LF 1710.020	1.50	1		LF 1801.025	1.90	1
Mörtel, Mortier chimique, Injection mortar (F120)	LF 1720.002	4.33	1/9*		LF 1720.002	4.33	1/9*		LF 1801.025	1.90	1
Rosette, Rosace	LF 1801.025	1.90	1		LF 1801.025	1.90	1		LF 3605.002	0.70	1/4*
Justierscheibe, Rondelle réglage, Adjusting shim	LF 3605.002	0.70	1/4*		LF 3605.002	0.70	1/4*		LF 3623.102	9.20	1
Anker, Ancre, Anchor	LF 3623.102	9.20	1		LF 3623.102	9.20	1		LF 3806.243	0.08	1/100*
Gewindekleber, Frein filet, Threadlocker	LF 3806.243	0.08	1/100*		LF 3806.243	0.08	1/100*				

T = 88mm Standard	1 Set	LF 3623.105.4~	22.20		LF 3623.205.4~	24.00		LF 3623.505.4~	21.35
	≥100 Set	LF 3623.105.6	21.00		LF 3623.205.6	22.65		LF 3623.505.6	20.15

T = 133mm XXL	1 Set	LF 3623.115.4~	25.70		LF 3623.225.4~	27.50		LF 3623.555.4~	25.05
----------------------	-------	-----------------------	--------------	--	-----------------------	--------------	--	-----------------------	--------------

Art. / Code	Détail		CHF
LF 1541.002.1	A	100	39.00
LF 1541.003.1	C	100	39.90
LF 1560.003.1	B	100	29.00
LF 1720.002.1	A / B / C	1	39.00
LF 3605.002.1	A / B	1	2.80
LF 3806.243.1	A / B	1	7.95

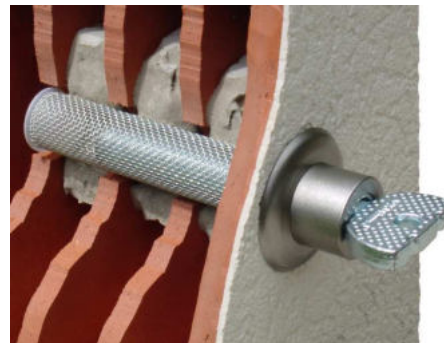

Bohrlocherstellung ohne Schlag. Isolations- und Leichtbausteine nur auf Anfrage.
 Perçage sans percussion. Briques légères pour maçonnerie seulement sur demande.
 Hole drilling without hammer drill. Insulating bricks and light bricks only on request.

Inox A2

Bohrer, Méche, Drill	LF 2060.160.3	Ø 16mm, Quadro SDS+		45.00
	LF 2060.200.3	Ø 20mm, Quadro SDS+		49.00

Bestellung Commande Order

Kunde, Client, Customer: _____

Kom., Commission: _____

Händler, Distributeur, Dealer: _____

www.lamifix.ch

lamifix@lamifix.ch

Tel: +41 55 225 48 48



2023/25

Schallschutz im Holz Isolation acoustique dans le bois Noise protection in wood

5 x geschraubt, vissé, screwed Q = 250 Kg.

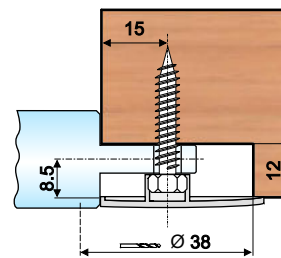
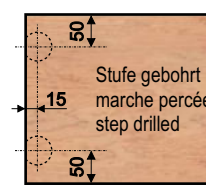
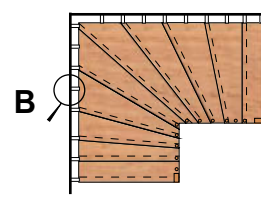
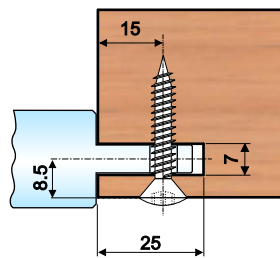
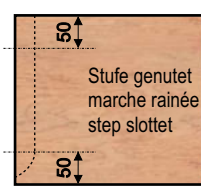
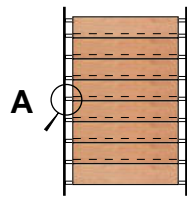
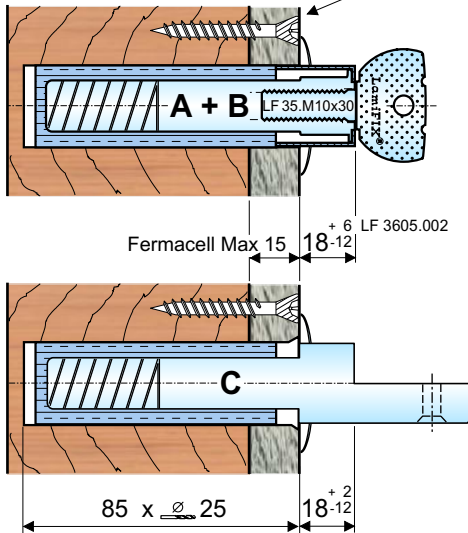

C = Schnellste Montage
Assemblage rapide
Fastest assembly

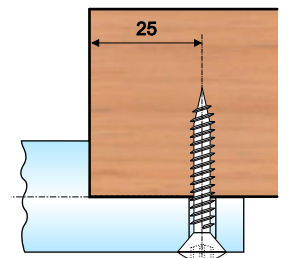
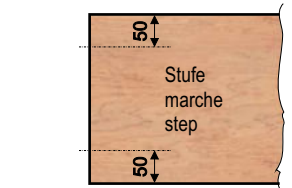

Set 6

	Art. / Code	CHF	SIK/ pcs		Art. / Code	CHF	SIK/ pcs		Art. / Code	CHF	SIK/ pcs
Verbinder, Raccord, Fixing	LF 1035.130	4.10	1		LF 1035.130	4.10	1		LF 1530.006	0.62	5*
Abdeckkappe, Capuchon, Cap	LF 1530.006	0.62	5*		LF 1435.001	1.90	1		LF 1541.003	0.40	1*
Schraube, Vis, Screw	LF 1541.002	0.39	1*		LF 1530.006	0.62	5*		LF 1620.016	3.95	1
Schraube, Vis, Screw	LF 1620.016	3.95	1		LF 1560.003	0.29	1*		LF 1801.025	1.90	1
Schallschutzdübel, Acoustique, Silencer	LF 1801.025	1.90	1		LF 1620.016	3.95	1		LF 3605.002	0.56	1/5*
Rosette, Rosace	LF 3605.002	0.56	1/5*		LF 1801.025	1.90	1		LF 3623.102	9.20	1
Justierscheibe, Rondelle réglage, Adjusting shim	LF 3623.102	9.20	1		LF 3605.002	0.56	1/5*		LF 3806.243	0.08	1/100*
Anker, Ancre, Anchor	LF 3806.243	0.08	1/100*		LF 3623.102	9.20	1				
Gewindekleber, Frein filet, Threadlocker					LF 3806.243	0.08	1/100*				

Set 6	1 Set	LF 3623.106.4~	20.80		LF 3623.206.4~	22.60		LF 3623.506.4~	20.05	
	≥100 Set	LF 3623.106.6	19.55		LF 3623.206.6	21.20		LF 3623.506.6	18.80	

Art. / Code	Détail	SIK*	CHF
LF 1530.006.1	A / B / C	100	12.50
LF 1541.002.1	A	100	39.00
LF 1541.003.1	C	100	39.90
LF 1560.003.1	B	100	29.00
LF 3605.002.1	A / B	1	2.80
LF 3806.243.1	A / B	1	7.95



Inox A2

Holzspiralbohrer, Mèche pour bois, Drill for wood **LF 2001.250.3** Ø 25mm HS 95.00

Bestellung Commande Order

Kunde, Client, Customer: _____

Kom., Commission: _____

Händler, Distributeur, Dealer: _____



www.lamifix.ch

lamifix@lamifix.ch

Tel: +41 55 225 48 48

2023/25

Schallschutz im Beton Isolation acoustique dans le béton Noise protection in concrete

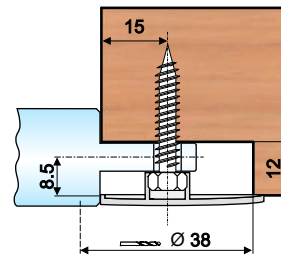
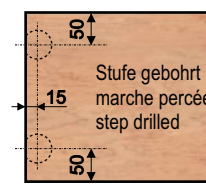
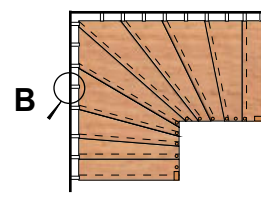
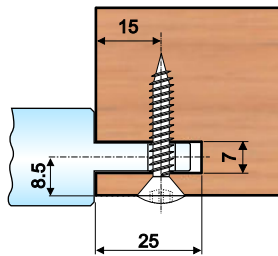
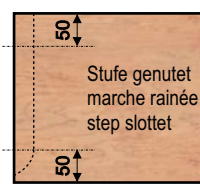
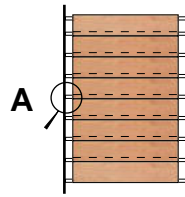
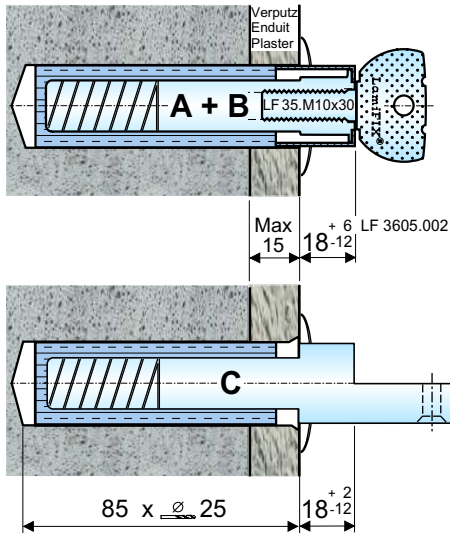

C = Schnellste Montage
Assemblage rapide
Fastest assembly

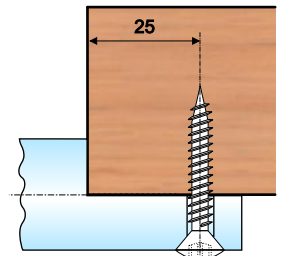
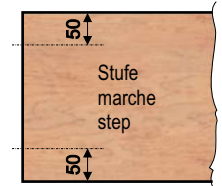

Set 7

- Verbinder, Raccord, Fixing
- Abdeckkappe, Capuchon, Cap
- Schraube, Vis, Screw
- Schallschutzdübel, Acoustique, Silencer
- Rosette, Rosace
- Justierscheibe, Rondelle réglage, Adjusting shim
- Anker, Ancre, Anchor
- Gewindekleber, Frein filet, Threadlocker

Art. / Code	CHF	Sik2 pcs
LF 1035.130	4.10	1
LF 1541.002	0.39	1*
LF 1620.016	3.95	1
LF 1801.025	1.90	1
LF 3605.002	0.56	1/5*
LF 3623.102	9.20	1
LF 3806.243	0.08	1/100*

Art. / Code	CHF	Sik2 pcs
LF 1035.130	4.10	1
LF 1435.001	1.90	1
LF 1560.003	0.29	1*
LF 1620.016	3.95	1
LF 1801.025	1.90	1
LF 3605.002	0.56	1/5*
LF 3623.102	9.20	1
LF 3806.243	0.08	1/100*

Art. / Code	CHF	Sik2 pcs
LF 1541.003	0.40	1*
LF 1620.016	3.95	1
LF 1801.025	1.90	1
LF 3623.202	13.20	1

Set 7	1 Set	LF 3623.107.4~	20.20	LF 3623.207.4~	22.00	LF 3623.507.4~	19.45
	≥100 Set	LF 3623.107.6	18.90	LF 3623.207.6	20.55	LF 3623.507.6	18.20

Art. / Code	Détail	☑*	CHF
LF 1541.002.1	A	100	39.00
LF 1541.003.1	C	100	39.90
LF 1560.003.1	B	100	29.00
LF 3605.002.1	A / B	1	2.80
LF 3806.243.1	A / B	1	7.95



Inox A2

Bohrer, Méche, Drill	LF 2060.250.3	Ø 25mm, Quadro SDS+	62.00
Armierungsbohrer, Méche béton armé, Rebar cutter	LF 2070.250.3	Ø 25mm, SDS+	115.00

Bestellung Commande Order

Kunde, Client, Customer: _____

Kom., Commission: _____

Händler, Distributeur, Dealer: _____



www.lamifix.ch

lamifix@lamifix.ch

Tel: +41 55 225 48 48

2023/25

Schallschutz im Ziegelstein Isolation acoustique dans la brique Noise protection in brick

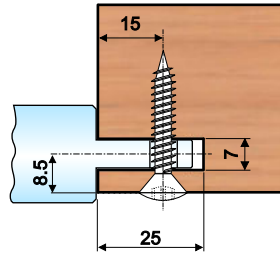
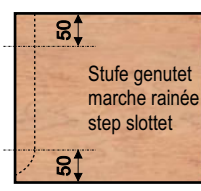
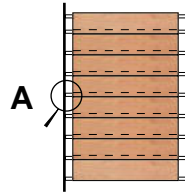
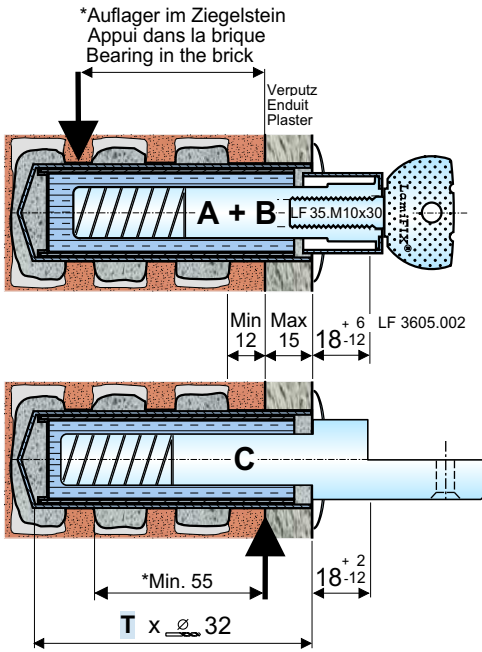

A

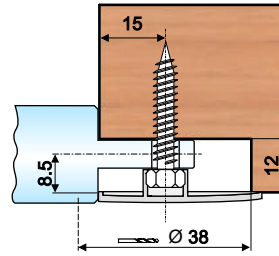
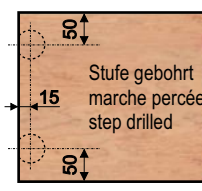
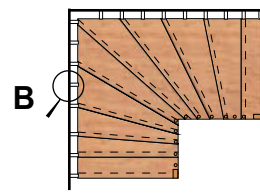

B

C = Schnellste Montage
Assemblage rapide
Fastest assembly

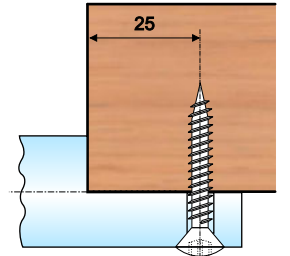
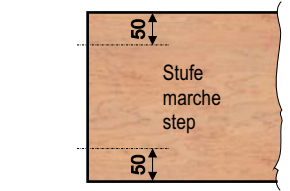

C

Set 8 + 9

	Art. / Code	CHF	SIK pcs		Art. / Code	CHF	SIK pcs		Art. / Code	CHF	SIK pcs
Verbinder, Raccord, Fixing	LF 1035.130	4.10	1		LF 1035.130	4.10	1				
Abdeckkappe, Capuchon, Cap					LF 1435.001	1.90	1				
Schraube, Vis, Screw	LF 1541.002	0.39	1*		LF 1560.003	0.29	1*		LF 1541.003	0.40	1*
Schallschutzdübel, Acoustique, Silencer	LF 1620.016	3.95	1		LF 1620.016	3.95	1		LF 1620.016	3.95	1
Rohrhülse, Douille tube, -sleeve	LF 1621...	3.40 - 3.95	1		LF 1621...	3.40 - 3.95	1		LF 1621...	3.40 - 3.95	1
Siebhülse, Douille de passoire, Screen tube	LF 1710.032	3.55 - 3.90	1		LF 1710.032	3.55 - 3.90	1		LF 1710.032	3.55 - 3.90	1
Mörtel, Mortier chimique, Injection mortar (F120)	LF 1720.002	5.57	1/7*		LF 1720.002	5.57	1/7*		LF 1720.002	5.57	1/7*
Rosette, Rosace	LF 1801.025	1.90	1		LF 1801.025	1.90	1		LF 1801.025	1.90	1
Justierscheibe, Rondelle réglage, Adjusting shim	LF 3605.002	0.70	1/4*		LF 3605.002	0.70	1/4*				
Anker, Ancre, Anchor	LF 3623.102	9.20	1		LF 3623.102	9.20	1		LF 3623.202	13.20	1
Gewindekleber, Frein filet, Threadlocker	LF 3806.243	0.08	1/100*		LF 3806.243	0.08	1/100*				

Set 8 T = 108mm Standard	1 Set	LF 3623.108.4~	32.85		LF 3623.208.4~	34.65		LF 3623.508.4~	31.95	
	≥100 Set	LF 3623.108.6	31.35		LF 3623.208.6	33.00		LF 3623.508.6	30.50	
Set 9 T = 128mm XXL	1 Set	LF 3623.109.4~	33.75		LF 3623.209.4~	35.55		LF 3623.509.4~	32.85	
	≥100 Set	LF 3623.109.6	32.25		LF 3623.209.6	33.90		LF 3623.509.6	31.40	

Art. / Code	Détail	SIK*	CHF
LF 1541.002.1	A	100	39.00
LF 1541.003.1	C	100	39.90
LF 1560.003.1	B	100	29.00
LF 1720.002.1	A / B / C	1	39.00
LF 3605.002.1	A / B	1	2.80
LF 3806.243.1	A / B	1	7.95



Bohrlocherstellung ohne Schlag. Isolations- und Leichtbausteine nur auf Anfrage.
Perçage sans percussion. Briques légères pour maçonnerie seulement sur demande.
Hole drilling without hammer drill. Insulating bricks and light bricks only on request.

Inox A2

Bohrer, Méche, Drill	LF 2060.160.3	Ø 16mm, Quadro SDS+		45.00	
	LF 2070.320.3	Ø 32mm, SDS+		125.00	
Weitere Werkzeuge, plus d'outils, more tools	LF 2070.320.4	Ø 32mm, SDS+, zum Mieten, à louer, to rent. 4 Wochen, 4 semaines, 4 weeks		30.00	23

Bestellung Commande Order

Kunde, Client, Customer: _____

Kom., Commission: _____

Händler, Distributeur, Dealer: _____



www.lamifix.ch

lamifix@lamifix.ch

Tel: +41 55 225 48 48

2023/25

Befestigung in Stahlwange Fixation dans limon en acier Fastener in steel stringer

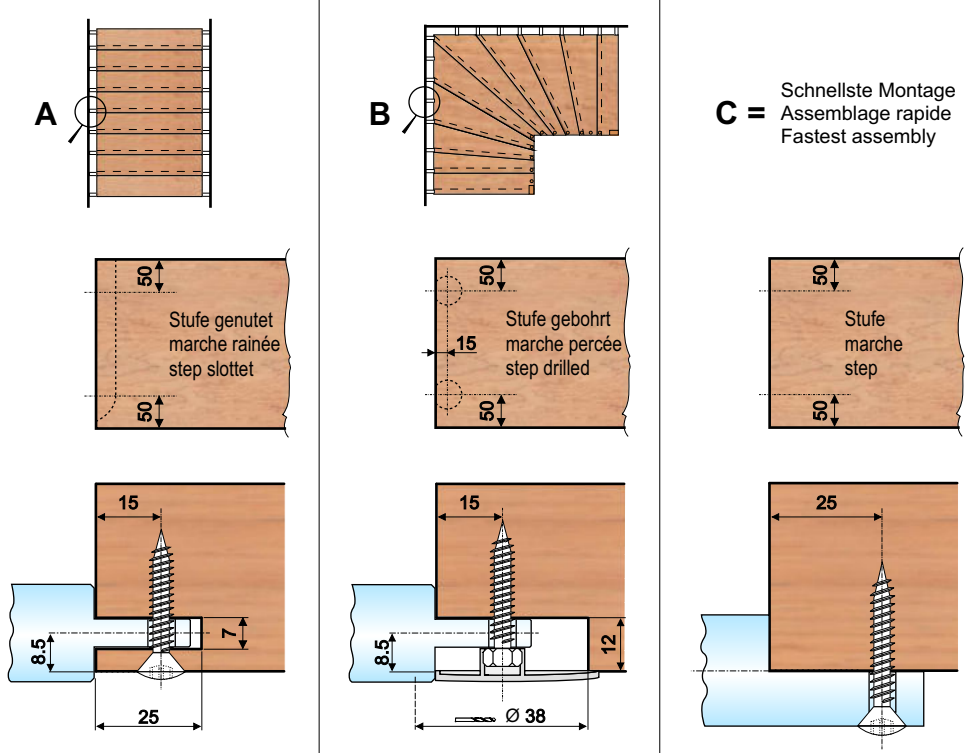
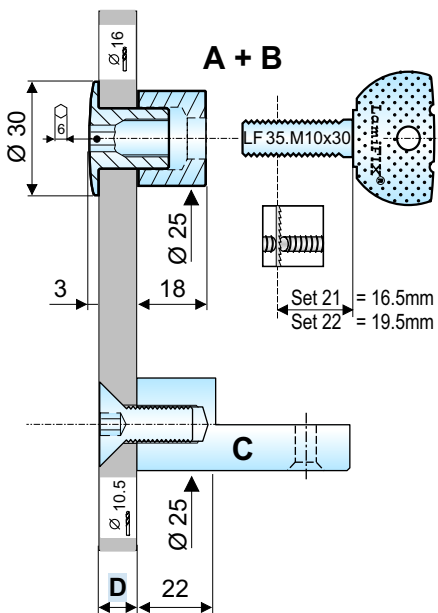

C = Schnellste Montage
Assemblage rapide
Fastest assembly

Set 21 + 22

Verbinde, Raccord, Fixing	Art. / Code	CHF	Stk/pcs	Verbinde, Raccord, Fixing	Art. / Code	CHF	Stk/pcs	Verbinde, Raccord, Fixing	Art. / Code	CHF	Stk/pcs
Abdeckkappe, Capuchon, Cap	LF 1035.130	4.10	1	Abdeckkappe, Capuchon, Cap	LF 1035.130	4.10	1	Abdeckkappe, Capuchon, Cap	LF 1035.130	4.10	1
Schraube, Vis, Screw	LF 1541.002	0.39	1*	Schraube, Vis, Screw	LF 1435.001	1.90	1	Schraube, Vis, Screw	LF 1560.003	0.29	1*
SK-Schraube, Vis à tête fraisée, Countersunk screw A2	LF 1571.998	2.40	1	SK-Schraube, Vis à tête fraisée, Countersunk screw A2	LF 1571.998	2.40	1	SK-Schraube, Vis à tête fraisée, Countersunk screw A2	LF 1541.003	0.40	1*
Zuschnitt, Coupe, Cutting	LF 3624.018	4.95	1	Zuschnitt, Coupe, Cutting	LF 3624.018	4.95	1	Zuschnitt, Coupe, Cutting	LF 1572.02. .	0.50 - 0.55	1*
Distanz, Distance	LF 3624.018	4.95	1	Distanz, Distance	LF 3624.018	4.95	1	Distanz, Distance	LF 3625.022	12.95	1
Rundmutter, Écrou rond, Cap-nut	LF 3813.030	7.95	1	Rundmutter, Écrou rond, Cap-nut	LF 3813.030	7.95	1	Rundmutter, Écrou rond, Cap-nut	LF 3813.030	7.95	1
Gewindekleber, Frein filet, Threadlocker	LF 3806.243	0.08	1/100*	Gewindekleber, Frein filet, Threadlocker	LF 3806.243	0.08	1/100*	Gewindekleber, Frein filet, Threadlocker	LF 3806.243	0.08	1/100*

Set 21	D = 6 - 9mm	1 Set	LF 3614.121.4~	19.85	LF 3614.221.4~	21.65	LF 3614.521.4~	13.95
		≥100 Set	LF 3614.121.6	18.85	LF 3614.221.6	20.50	LF 3614.521.6	13.40
Set 22	D = 9 - 12mm	1 Set	LF 3614.122.4~	19.85	LF 3614.222.4~	21.65	LF 3614.522.4~	14.00
		≥100 Set	LF 3614.122.6	18.85	LF 3614.222.6	20.50	LF 3614.522.6	13.50

Art. / Code	Détail	Stk*	CHF
LF 1541.002.1	A	100	39.00
LF 1541.003.1	C	100	39.90
LF 1560.003.1	B	100	29.00
LF 1572.020.1	Set 21 C	100	50.00
LF 1572.025.1	Set 22 C	100	55.00
LF 3806.243.1	A / B / C	1	7.95



Eindrehwerkzeug, Outil à visser, Screw tool	LF 2150.030.3	42.00	LF 2151.036.3	42.00
---	----------------------	-------	----------------------	-------

Metallwange direkt bei: z.B:
Limon en acier, directement chez:
Steel stringer, directly by:

Lastech AG
Birrfieldstr. 35
CH-5507 Mellingen

Tel
Email
+41 56 481 80 80
technik@lastech.ch

Richtpreis für Stahlwange: 4.1m 280x10mm inkl. RAL Pulverbeschichtung
Prix indicatif pour limon en acier incl. revêtu par poudre RAL
Guiding price for steel stringer, incl. powder-coating RAL

1 Stk. ~ 550.00 CHF
2 Stk. ~ 500.00 CHF

Bestellung Commande Order

Kunde, Client, Customer: _____

Kom., Commission: _____

Händler, Distributeur, Dealer: _____

www.lamifix.ch

lamifix@lamifix.ch

Tel: +41 55 225 48 48



2023/25

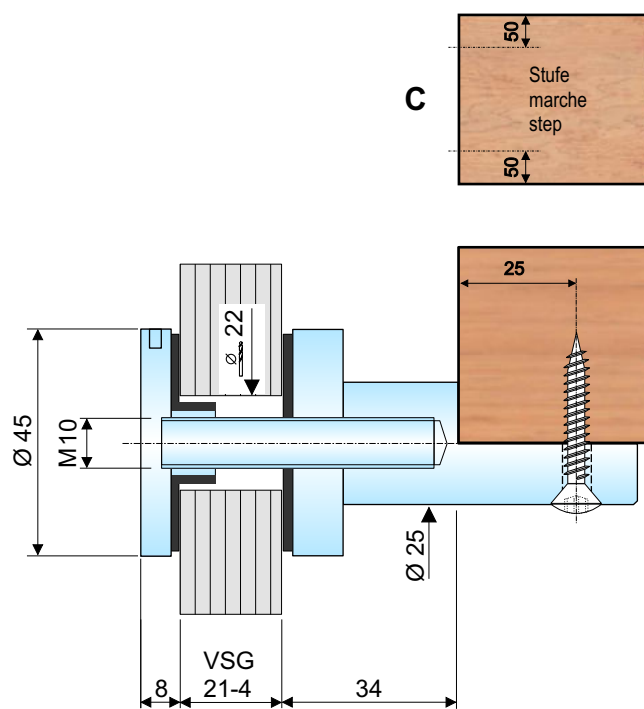

Befestigung an VSG Glas
Fixation dans verre de sécurité feuilleté
Fastener in laminated safety glass



Set 50

C

	Art. / Code	CHF	
Schraube, Vis, Screw	LF 1541.003	0.40	1*
Auflager, Raccord, Step holder	Inox A2 LF 3625.022	12.95	1
Glaspunkthalter, Porte-verre, Glass holder	Inox A2 LF 4150.450	39.50	1
Gewindekleber, Frein filet, Threadlocker	LF 3806.243	0.08	1/100*

Set 50	1 Set	LF 4150.550.4~	52.95	
	≥100 Set	LF 4150.550.6	50.40	

Art. / Code	Détail	 *	CHF
LF 1541.003.1	C	100	39.90
LF 3806.243.1	C	1	7.95

Hakenschlüssel, Clé à ergot, Hook wrench	LF 4150.451.3	37.00	
--	----------------------	--------------	---



VSG Glas, direkt bei:
Verre de sécurité, directement chez:
Safety glass, directly by:

Glas Trösch AG
 Zweigniederlassung
 CH-9015 St. Gallen Winkeln

Tel +41 71 313 02 02
 Fax +41 71 313 02 03
 Email infostgallen@glastroesch.ch

Glas Trösch AG
 Isolier- und Sicherheitsglas
 CH-4922 Bützberg

Tel +41 62 958 51 51
 Fax +41 62 958 27 62
 Email isobuetzberg@glastroesch.ch

4

Montageanleitung für seitliche Stufenbefestigungen
 Instruction de montage pour fixations latérales de marches
 Mounting instruction for lateral step fixings
 Istruzioni per il montaggio, fissaggio laterale dei gradini



<p>1</p> <p>≥ 22 Ø 40</p> <p>Schablone herstellen Fabriquez gabarit de perçage Fabricate a drill jig Fabbricare una dima</p>	<p>2</p> <p>LF 2115.040</p> <p>Schablone anschrauben Vissez le gabarit de perçage Screw on drill jig Fissare la dima</p>	<p>3</p> <p>LF 2116.040</p> <p>Führungshülse einsetzen Insérez le douille de guidage Insert guide bush Posizionare la bussola guida</p>
<p>4</p> <p>LF 2117.040</p> <p>Ev. mit Ring anschrauben Ev. vissez avec l'anneau Ev. screw on with ring Ev. Fissare con anello</p>	<p>5</p> <p>LF 2119... LF 2120... LF 2060... LF 2070...</p> <p>Bohrbüchsen auf Bohrer schieben Mettez le canon de perçage sur la mèche Pull drill guide over drill Inserire la bussola sul trapano</p>	<p>6</p> <p>Alle Positionen bohren Percez toutes les positions Drill holes on all positions Eseguire tutti i fori</p>
<p>7</p> <p>Bolzen einbauen Installez les boulons Install fittings Installare i bulloni</p>	<p>8</p> <p>Rosetten umplatzieren Déplacez les rosaces Move supports for fixing Riposizionare le rosette</p> <p>Zentriering einsetzen Insérez la douille de centrage Insert sleeve Inserire il manicotto</p>	<p>9</p> <p>Für letzte Bohrungen, 3 - 6 wiederholen Pour dernier perçages, répétez 3 - 6 For last drill holes, repeat 3 - 6 Per ultime perforazioni, ripetere 3 - 6</p> <p>Sichern Sécurisez Secure Bloccare</p>
<p>10</p> <p>T 0 bis 18 mm T</p> <p>T = Mindest Einbautiefe T = Profondeur de montage minimale T = Minimum mounting depth T = Profondità minimale</p>	<p>11</p> <p>18 - 24 LF 3605.002 18 - 20</p> <p>Max. 3 Scheiben zum Ausgleichen Max. 3 rondelles pour réglage Max. 3 adjusting shims to adjust Max. 3 rondelle distanziatrice</p>	<p>12</p> <p>LF 3601... LF 1801.025 LF 3806.243.1</p> <p>Hülsen, Rosetten + Verbinder montieren Couvercles, rosaces + élém. d'assemblages Mount cover, rosettes + fixing element Inserire le rosette sui legami avvitare i perni</p>

Set Nr:
5 / 7 / 8 / 9

Set Nr:
1 / 2 / 3624

* Komplet einerschrauben (Gewindenspiel aufheben)
 Vissez complètement (supprimez la tolérance filet)

Screw in completely (remove thread tolerance)
 Avvitare completo (sopprimere tolleranza filetto)

Bestellung Commande Order

Kunde, Client, Customer: _____

Kom., Commission: _____

Händler, Distributeur, Dealer: _____



www.lamifix.ch

lamifix@lamifix.ch

Tel: +41 55 225 48 48

2023/25

		Art. / Code					
	Bohrer für Detail B	LF 2011.380.3	Ø 38mm	HW	1	93.00	
	Mèche pour détail B	→ 1435.001 + 1436. ...					
	Drill for detail B						
	Bohrer für Holz	LF 2001.250.3	Ø 25mm	HS	1	95.00	
	Mèche pour bois	→ Set 1 / 2 / 3624					
	Bohrer Quadro SDS+	LF 2060.160.3	Ø 16mm	HW	1	45.00	
	Mèche	→ Set 5 / 8 / 9					
	Drill	LF 2060.200.3	Ø 20mm	HW	1	49.00	
		→ Set 5					
	Armierungsbohrer	LF 2070.200.3	Ø 20mm	HW	1	99.00	
	Mèche pour béton armé SDS+	→ Set 5					
	Rebar cutter	LF 2070.250.3	Ø 25mm	HW	1	115.00	
		→ Set 7					
	Bohrer für Ziegelstein	LF 2070.320.3	Ø 32mm	HW	1	125.00	
	Mèche pour briques SDS+	→ Set 8 + 9					
	Drill for bricks						
	Rosetten z. Fixieren der Bohrschablone	LF 2115.040.3	Ø 40mm		2	59.00	
	Rosaces pour fixer le gabarit de perçage						
	Screwing supports for fixing drill jig						
	Führungshülse für Bohrbüchsen	LF 2116.040.3		gehärtet	1	46.00	
	Douille de guidage pour canon de perçage			trempeée			
	Guide bush for drill guide			hardened			
	Anschraubring für Führungshülse	LF 2117.040.3			1	32.00	
	Anneau pour douille de guidage						
	Screwing ring for guide bush						
	Bohrbüchse für Holzbohrer	LF 2118.250.3	Ø 25mm	gehärtet	1	40.00	
	Canon de perçage pour mèche pour bois	→ 2001.250		trempeée			
	Drill guide for wood drill			hardened			
	Bohrbüchse für Steinbohrer	LF 2119.160.3	Ø 16mm	gehärtet	1	40.00	
	Canon de perçage p. mèche pour pierre	→ 2060.160		trempeée			
	Drill guide for rock drill			hardened			
	Bohrbüchse für Armierungsbohrer	LF 2120.200.3	Ø 20mm	gehärtet	1	40.00	
	Canon de perçage p. mèche pour fer à béton	→ 2070.200		trempeée			
	Drill guide for rebar cutter			hardened			
	Bohrbüchse für Ziegelstein	LF 2120.320.3	Ø 32mm	gehärtet	1	40.00	
	Canon de perçage pour briques	→ 2070.320		trempeée			
	Drill guide for bricks			hardened			
	Set bestehend aus	LF 2121.001.4	LF 2115.040 - 2117.040 + LF 2118.250 - 2120.320			399.00	
	Set composé de						
	Set consisting of						
	Einzel-Set mieten	LF 2121.999.4		pro Woche		20.00	
	Set individuel à louer			par semaine			
	Individual set to rent			per week			
	Eindrehwerkzeug	LF 2150.030.3	→ LF 30 + LF 35		1	42.00	
	Outil à visser	○ 9mm					
	Screw tool						
		LF 2150.036.3	→ Set 1 / 2 / 3624	A + B	1	42.00	
		○ 9mm					
		LF 2151.036.3	→ Set 1 / 2 / 3624	C	1	42.00	
		○ 9mm					
	Fräser für Nute, Detail A	LF 2199.105.3	Ø 105 / 30mm	HW	1	275.00	
	Fraise à rainurer 7 x 25mm détail A						
	Cutter for grooving detail A						

4

Bestellung Commande Order

Kunde, Client, Customer: _____

Kom., Commission: _____

Händler, Distributeur, Dealer: _____



www.lamifix.ch

lamifix@lamifix.ch

Tel: +41 55 225 48 48

2023/25

Ø 10



Hartholz
Bois dur
Hardwood
☑ > 165 x 45

Ohne Verschraubung
Sans vissage
Without screwing

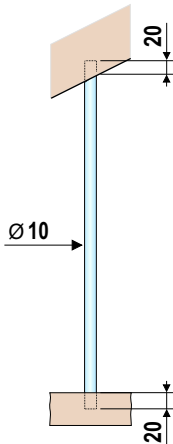

Mit Verschraubung
Avec vissage
With screwing

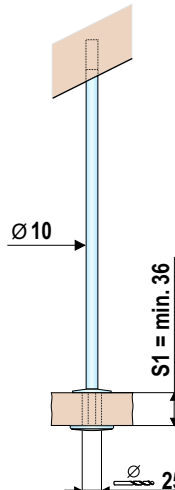

Mit Verschraubung
Avec vissage
With screwing

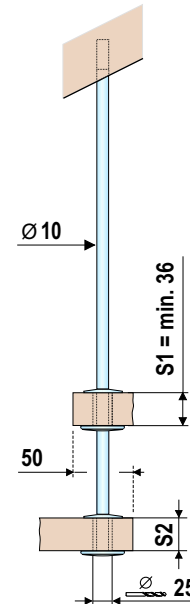

Art. / Code	Stk. pcs	CHF	
LF 3905.097 Stange, Barre, Bar 1m	1	6.95	
LF 3905.997 Zuschnitt, Coupe, Cutting	1	2.40	

Set 31 / 32

Art. / Code	Stk. pcs	CHF	
LF 1441.010 Muffe, Manchon, Thread	1*	1.04	
LF 3803.037 End-Rosette, -terminale M10	1	9.95	
LF 3901.001 Holzhülse, Douille, Bush	1*	2.00	
LF 3911.031 Deck-Rosette, Ring cover M10	1	7.20	
LF 3912.031 Deck-Rosette, Ring cover M16	1	8.50	
LF 3912.037 Trag-Rosette, -portante M16	1	9.95	
LF 3806.243 Gewindekleber, Frein filet	1/100*	0.08	
1 Set	LF 3900.031.4~	20.25	
≥100 Set	LF 3900.031.6	19.60	

Set 31

Stk. pcs	CHF	
1*	1.04	
1	9.95	
1*	2.00	
1	7.20	
1	8.50	
1	9.95	
1/100*	0.08	
1	20.25	
1	19.60	

Set 32

Stk. pcs	CHF	
1*	1.04	
1	9.95	
1*	2.00	
1	7.20	
1	8.50	
1	9.95	
1/100*	0.08	
1	38.70	
1	37.25	

Inox-Stange, Barre, Bar

Art. / Code	Stk. pcs	CHF	
LF 3905.097 Stange, Barre, Bar 1m	≥100 Stk	m ¹ = 6.45	
LF 3905.197 Stange, Barre, Bar 2m	≥ 50 Stk	12.90 m ¹ = 6.45	
LF 3905.600 Stange, Barre, Bar 6m	≥ 20 Stk	38.70 m ¹ = 6.45	
LF 3905.997 Zuschnitt, Coupe, Cutting	1	2.40	
LF 3905.998 Gewindeschneiden, Fileter M10	2	6.20	
LF 3905.999 Schweissen, Souder, Welding	1	6.90	

Art. / Code	Set		CHF
LF 1441.010.1	31 / 32	25	26.00
LF 3806.243.1	31 / 32	1	7.95
LF 3901.1	31 / 32	10	20.00

- ...001.1 Buche, Hêtre, Beech
- ...002.1 Ahorn, Érable, Maple
- ...003.1 Eiche, Chêne, Oak
- ...004.1 Esche, Frêne, Ash
- ...005.1 Europ. Nuss, Noyer, Walnut
- ...Auf Anfrage, Sur demande, On request

Montageanleitung für Stufenaufhängungen
 Instruction de montage pour suspension de marches
 Mounting instruction for step hangers
 Istruzioni per il montaggio del fissaggio dei gradini

Ø 10



1

Handlauf bohren
 Perçez dans la main courante
 Drill hole in handrail
 Forare

2

Muffe eindrehen
 Vissez le manchon
 Screw in thread sleeve
 Inserire il dado autobloccante

3

Holzbohle einkleben + abschleifen
 Collez la douille en bois + poncez
 Glue wood bush + grind it
 Incollare bossolo + levigare

4

Geschweisst
 Soudé
 Welded
 Saldati

Stange eindrehen
 Vissez la barre
 Screw in bar
 Avvitare barra

5

Ausrichten + Rosette konter-verschrauben
 Ajustez + contrevissez la rosace
 Adjust + counter-screw rosette
 Allineare + avvitare rosetta

6

Montage von oben nach unten
 Montage du haut vers le bas
 Mounting top down
 Montaggio di sopra per sotto

* Alle Verschraubungen wieder lösbar sichern.
 Sécurisez le vissage de manière re-devissable.

Secure all screwings afresh unlockable.
 Bloccare l'avvitamento alla maniera svitabile.

Bestellung Commande Order

Kunde, Client, Customer: _____

Kom., Commission: _____

Händler, Distributeur, Dealer: _____

www.lamifix.ch

lamifix@lamifix.ch

Tel: +41 55 225 48 48



2023/25

Zwischenstäbe / Rücklauf
Sans vissage / Garde-corps
Without screwing / Railing

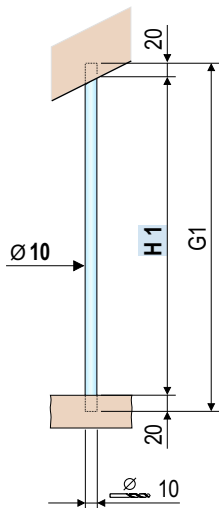

Mit Verschraubung
Avec vissage
With screwing

Set 31

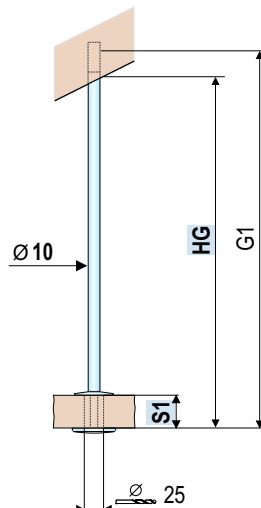

Set 32

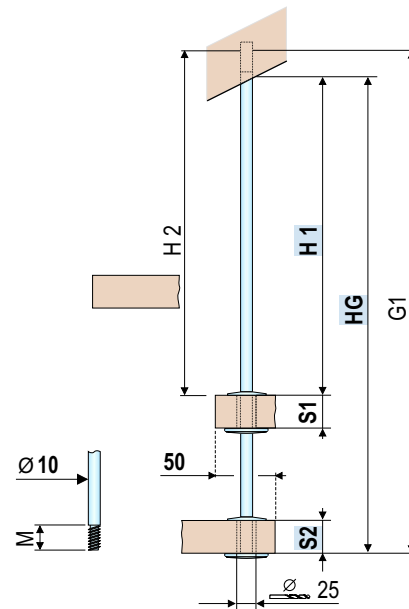

No	H1	+40	=G1	Stk	HG	+35	=G1	S1	-6	=M	Stk	HG	+35	=G1	H1	+39	=H2	S2	-6	=M	Stk	
1		+40				+35			-6				+35			+39			-6			
2		+40				+35			-6				+35			+39			-6			
3		+40				+35			-6				+35			+39			-6			
4		+40				+35			-6				+35			+39			-6			
5		+40				+35			-6				+35			+39			-6			
6		+40				+35			-6				+35			+39			-6			
7		+40				+35			-6				+35			+39			-6			
8		+40				+35			-6				+35			+39			-6			
9		+40				+35			-6				+35			+39			-6			
10		+40				+35			-6				+35			+39			-6			
11		+40				+35			-6				+35			+39			-6			
12		+40				+35			-6				+35			+39			-6			
13		+40				+35			-6				+35			+39			-6			
14		+40				+35			-6				+35			+39			-6			
15		+40				+35			-6				+35			+39			-6			
16		+40				+35			-6				+35			+39			-6			
17		+40				+35			-6				+35			+39			-6			
18		+40				+35			-6				+35			+39			-6			
19		+40				+35			-6				+35			+39			-6			
20		+40				+35			-6				+35			+39			-6			
21		+40				+35			-6				+35			+39			-6			
22		+40				+35			-6				+35			+39			-6			
23		+40				+35			-6				+35			+39			-6			
24		+40				+35			-6				+35			+39			-6			
25		+40				+35			-6				+35			+39			-6			
26		+40				+35			-6				+35			+39			-6			
27		+40				+35			-6				+35			+39			-6			
28		+40				+35			-6													
29		+40				+35			-6													
30		+40				+35			-6													

Holzart
Sorte de bois
Type of wood

Bestellung Commande Order

Kunde, Client, Customer: _____

Kom., Commission: _____

Händler, Distributeur, Dealer: _____

www.lamifix.ch

lamifix@lamifix.ch

Tel: +41 55 225 48 48



2023/25

Aufhängung an Beton Suspension en béton Hanger at concrete

Aufhängung an Weichholzbalken Suspension en solive de bois blanc Hanger at softwood ceiling joist

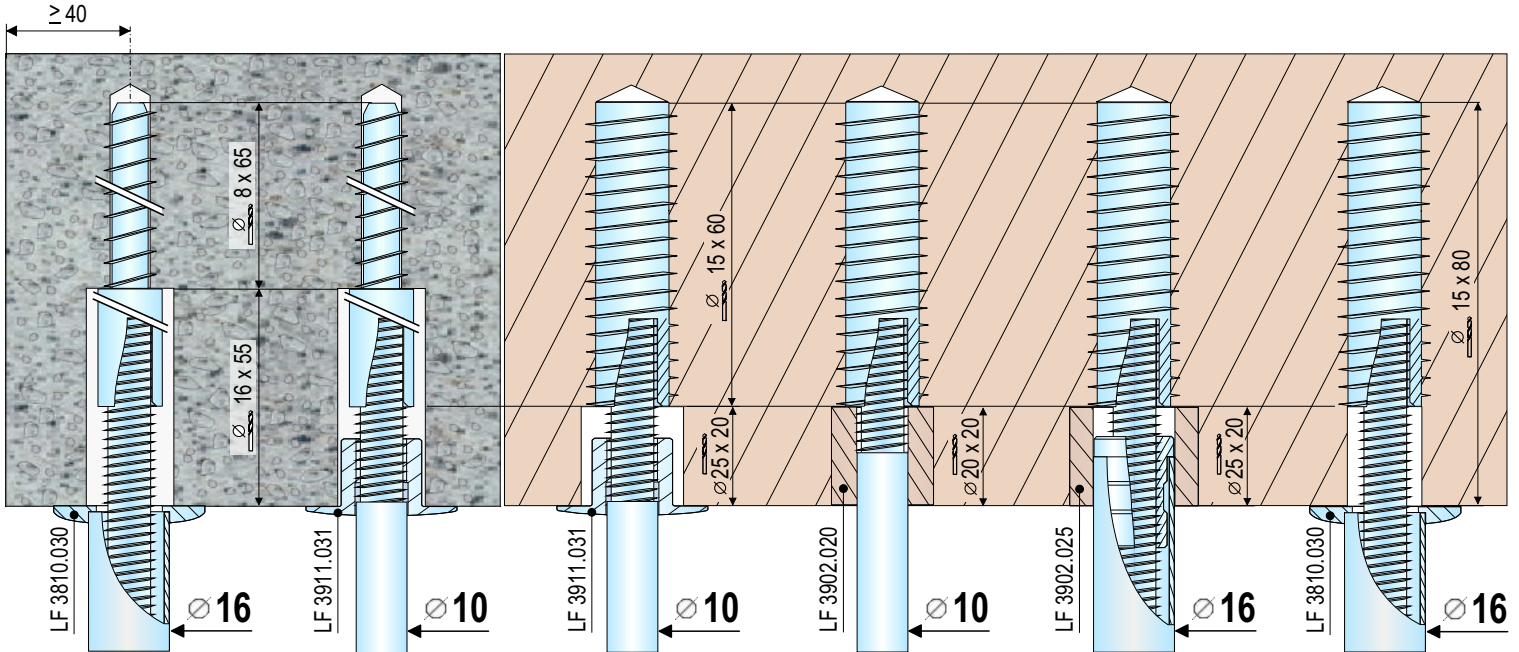

	Set 97	Set 98	Set 99	Set 100	Set 101	Set 102
Höhenverstellbar Réglable en hauteur Height adjustable						
	± 0mm	± 2mm	± 2mm	± 5mm	± 5mm	± 0mm
1 Set	6.00	10.20	11.70	6.60	6.70	7.50

Eindrehhilfe, Aide à visser, Screw tool	20.00
LF 1572.010.3 M10	
Bohrbüchse, Canon de perçage, Drill guide	20.00
LF 1572.008.3 ∅ 16 / 8 x 100mm	

Eindrehwerkzeug, Outil à visser, Screw tool	99.50
LF 1442.011.3 M10	



Bestellung Commande Order

Kunde, Client, Customer: _____

Kom., Commission: _____

Händler, Distributeur, Dealer: _____

www.lamifix.ch

lamifix@lamifix.ch

Tel: +41 55 225 48 48



2023/25

Ø 16



Ohne Verschraubung Sans vissage Without screwing

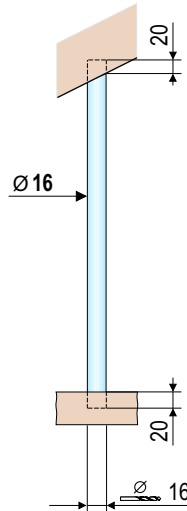

Mit Verschraubung Avec vissage With screwing

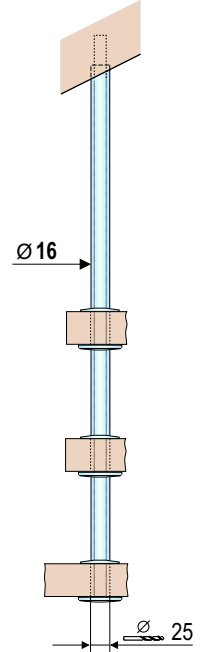
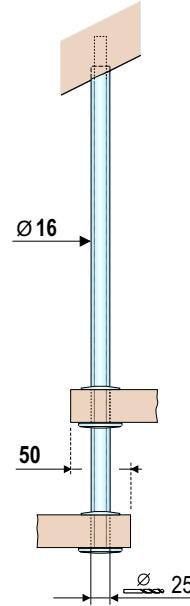
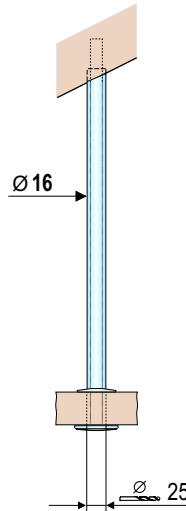

Art. / Code	Stk. pcs	CHF	Stk/pcs
LF 3805.097 Rohr, tube	1m	1	6.95
LF 3805.999 Zuschnitt, Coupe, Cutting	1	2.40	35

Set 11

Set 12

Set 13

Set 11 / 12 / 13	Stk. pcs	CHF	Stk/pcs	Stk. pcs	CHF	Stk/pcs	Stk. pcs	CHF	Stk/pcs
LF 1441.010 Muffe, Manchon, Thread	1*	1.04		1*	1.04		1*	1.04	
LF 1455.010 Anschlag, Butée, End stop	1	2.90		1	2.90		1	2.90	
LF 1456.010 Kupplung, Accouplement							1	1.50	
LF 1456.083 Gewindestift + Kupplung				1	4.50		1	4.50	
LF 3802.037 Trag-Rosette, -portante				1	9.85		2	19.70	
LF 3803.037 End-Rosette, -terminale	1	9.95		1	9.95		1	9.95	
LF 3806.001 Höhenausgleich, Ajustage				1*	0.16		2*	0.32	
LF 3806.130 Hülse, Isolante, Silencer	1*	0.75		2	1.50		3*	2.25	
LF 3806.160 Rond. Isol. Silenc. Ring	2*	0.38		4*	0.76		6*	1.14	
LF 3806.243 Gewindekleber, Adhésive	1/100*	0.08		1/100*	0.08		1/100*	0.08	
LF 3811.030 Deck-Rosette, Ring cover	1	4.95		2	9.90		3	14.85	
1 Set				LF 3800.011.4~	20.05		LF 3800.012.4~	40.65	
≥100 Set				LF 3800.011.6	19.30		LF 3800.012.6	40.40	

Gewindestangen mit Inbus 5mm Tiges filetéés, Threaded rods

Art. / Code	Set	Stk. pcs	CHF	Stk/pcs
LF 1571.097 Gewindestange M10	1m	1	4.45	44
LF 1571.197 Tige filetéée	2m	6.90		
LF 1571.300 Threaded rod	3m	13.50		
LF 1571.998 Zuschnitt, Coupe, Cutting		1	2.40	
LF 1571.999 Verpressen, Pression, Stamp.		1	1.30	

Inox-Rohr, Tube

Art. / Code	Set	Stk. pcs	CHF	Stk/pcs
LF 3805.097 Rohr, Tube	1m	≥100 Stk	m' = 6.45	1
LF 3805.197 Rohr, Tube	2m	≥ 50 Stk	12.90 m' = 6.45	13.90
LF 3805.600 Rohr, Tube	6m	≥ 20 Stk	38.70 m' = 6.45	41.70
LF 3805.999 Zuschnitt, Coupe, Cutting		1	2.40	35
		2	4.80	35
		3	7.20	35

Art. / Code	Set	Stk. pcs	CHF
LF 1441.010.1	11 - 13	25	26.00
LF 3806.001.1	12 + 13	100	16.00
LF 3806.130.1	11 - 13	10	7.50
LF 3806.160.1	11 - 13	100	19.00
LF 3806.243.1	11 - 13	1	7.95

Montageanleitung für Stufenaufhängungen
 Instruction de montage pour suspension de marches
 Mounting instruction for step hangers
 Istruzioni per il montaggio del fissaggio dei gradini

Ø 16



<p>1</p> <p>Handlauf bohren Percez dans la main courante Drill hole in handrail Forare</p>	<p>2</p> <p>Muffe eindrehen Vissez le manchon Screw in thread sleeve Inserire il dado autobloccante</p>	<p>3</p> <p>Gewindestange mit Anschlag + Dämpfungsring Tige filetée avec butée + rondelle isolante Threaded rod with end stop top + silencer ring Fissare barra filettata + anello d'assorbimento</p>
<p>4</p> <p>Ca. alle 500mm eine Dämpfungshülse Env. tous 500mm une douille isolante Approx. all 500mm one silencer bush Circa. tutti 500mm un anello d'assorbimento</p>	<p>5</p> <p>Rohr, Dämpfungsring + Deck-Rosette Tube, rondelle isolante + rosace de haut Tube, silencer ring + ring cover top Tubo, anello + rosetta di copertura</p>	<p>6</p> <p>Bohrungen in den Stufen Ø 25mm Perçages dans les marches Ø 25mm Drill hole in steps Ø 25mm Perforazioni in gradini Ø 25mm</p>
<p>7</p> <p>Stufe montieren + nivellieren... Montez + nivelez la marche... Step mounting + levelling... Allineare il gradino...</p>	<p>8</p> <p>...Rosette + Gew.-Stange konter-verschrauben ...contre-vissez la rosace + la tige filetée ...rosette + threaded rods counter-screwing ...avvitare rosetta</p>	<p>9</p> <p>Alle Gewinde mind. 10mm verschrauben Vissez filets à min. 10mm Screw in all threads min. 10mm Avvitare min. 10mm tutti filetti</p>

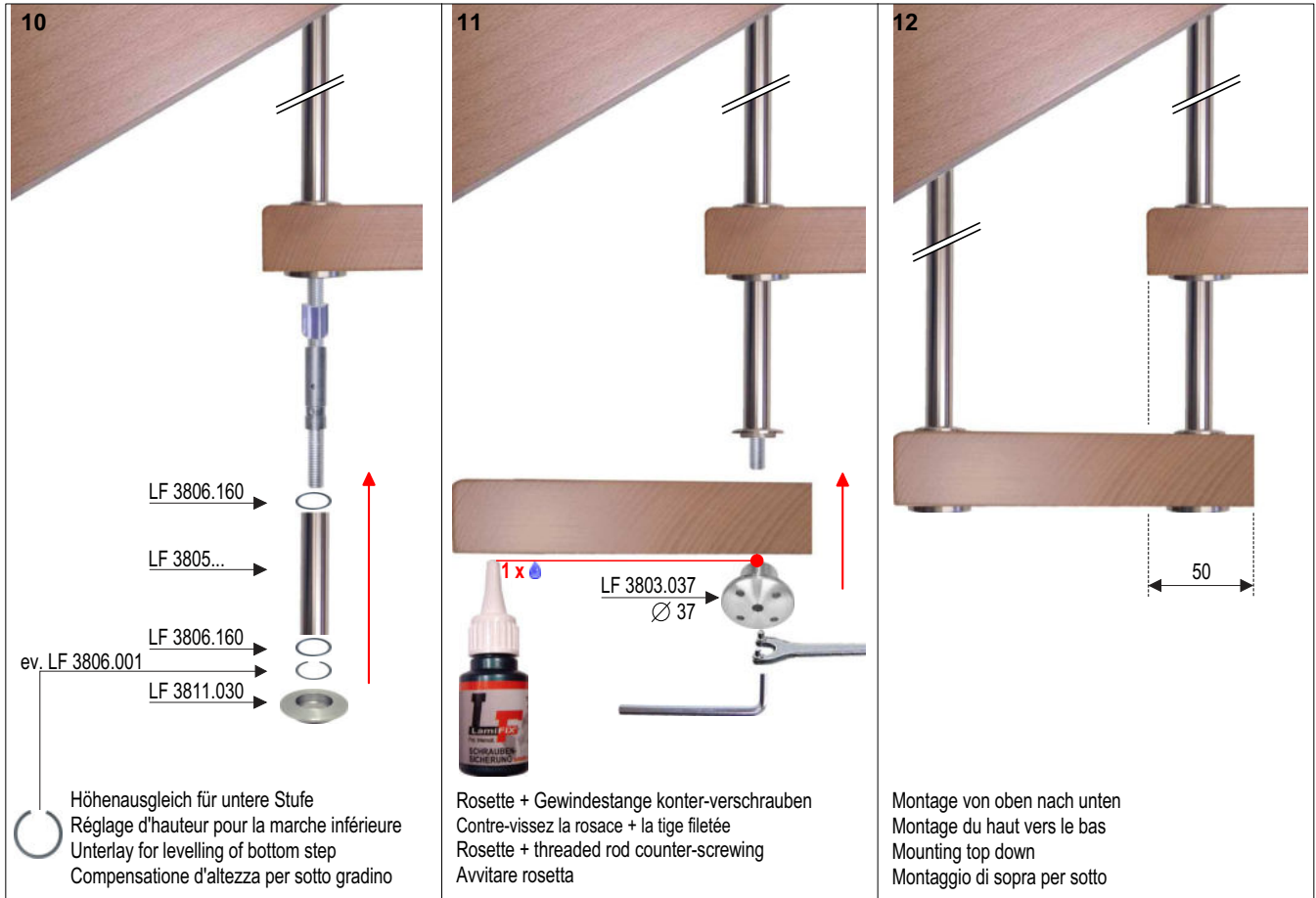

Alle Verschraubungen wieder lösbar sichern.
 Sécurisez le vissage de manière re-devissable.
 Secure all screwings afresh unlockable.
 Bloccare l'avvitamento alla maniera svitabile.



Bestellung Commande Order

Kunde, Client, Customer: _____

Kom., Commission: _____

Händler, Distributeur, Dealer: _____

www.lamifix.ch

lamifix@lamifix.ch

Tel: +41 55 225 48 48



2023/25

Zwischenstäbe / Rücklauf
Sans vissage / Garde-corps
Without screwing / Railing

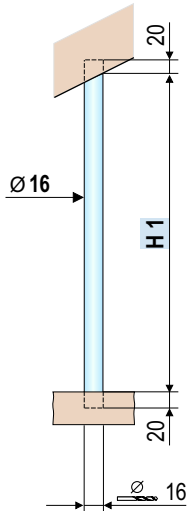

Mit Verschraubung
Avec vissage
With screwing **Set 11**

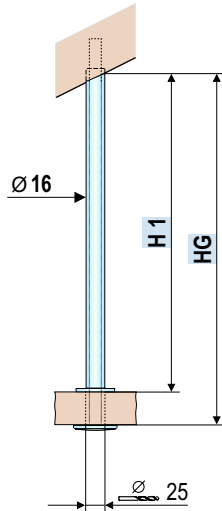

Set 12

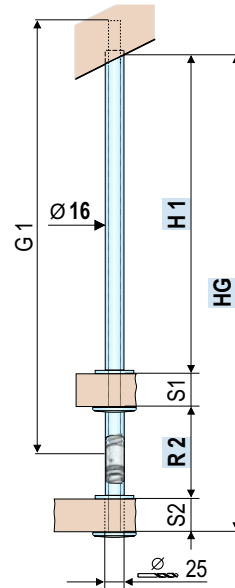

Set 13

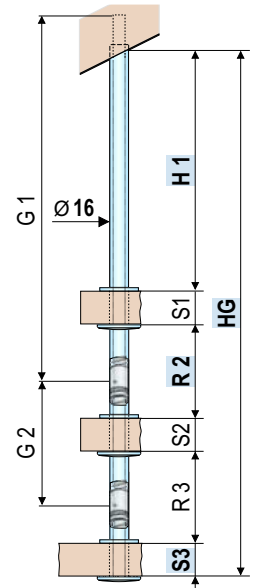

No	H1	+40	=R1	Stk	HG	+32	=G1	H1	+10	=R1	Stk	HG	-36	=G1	H1	+10	=R1	=R2	Stk	HG	R2	S3	H1	Stk	
1		+40				+32			+10				-36			+10									
2		+40				+32			+10				-36			+10									
3		+40				+32			+10				-36			+10									
4		+40				+32			+10				-36			+10									
5		+40				+32			+10				-36			+10									
6		+40				+32			+10				-36			+10									
7		+40				+32			+10				-36			+10									
8		+40				+32			+10				-36			+10									
9		+40				+32			+10				-36			+10									
10		+40				+32			+10				-36			+10									
11		+40				+32			+10				-36			+10									
12		+40				+32			+10				-36			+10									
13		+40				+32			+10				-36			+10									
14		+40				+32			+10				-36			+10									
15		+40				+32			+10				-36			+10									
16		+40				+32			+10				-36			+10									
17		+40				+32			+10				-36			+10									
18		+40				+32			+10				-36			+10									
19		+40				+32			+10				-36			+10									
20		+40				+32			+10				-36			+10									
21		+40				+32			+10				-36			+10									
22		+40				+32			+10				-36			+10									
23		+40				+32			+10				-36			+10									
24		+40				+32			+10				-36			+10									
25		+40				+32			+10				-36			+10									
26		+40				+32			+10				-36			+10									
27		+40				+32			+10				-36			+10									
28		+40				+32			+10				-36			+10									
29		+40				+32			+10				-36			+10									
30		+40				+32			+10				-36			+10									

Bestellung Commande Order

Kunde, Client, Customer: _____

Kom., Commission: _____

Händler, Distributeur, Dealer: _____

www.lamifix.ch

lamifix@lamifix.ch

Tel: +41 55 225 48 48



2023/25

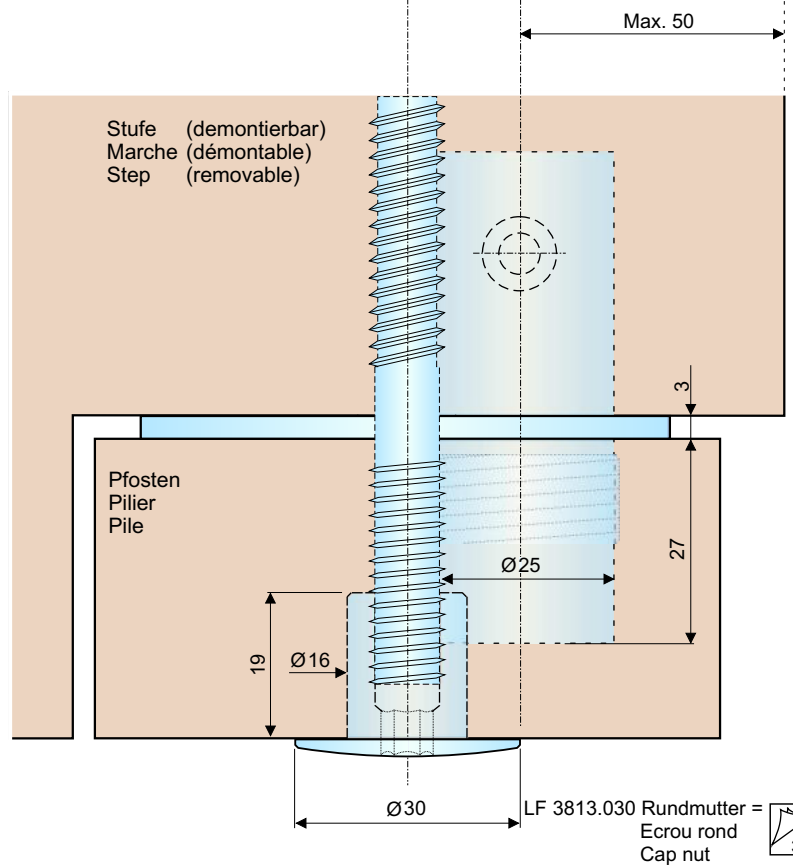
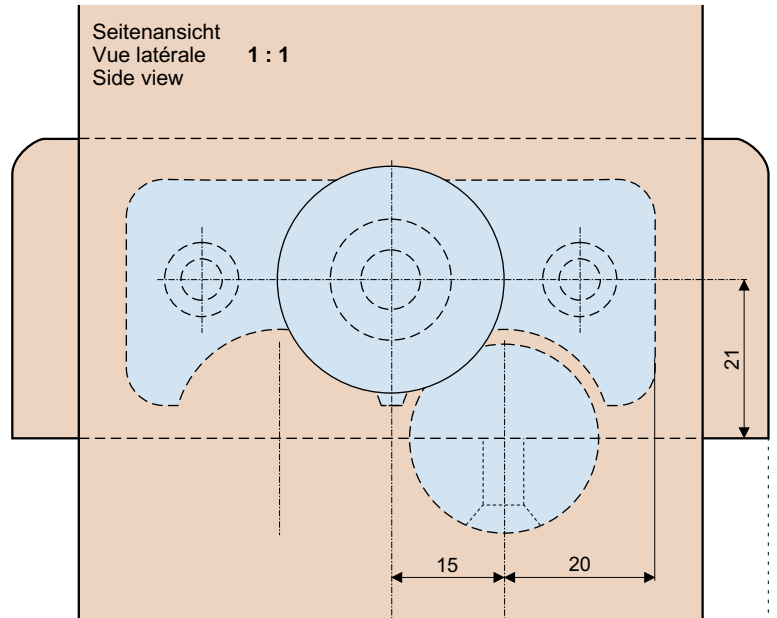

Set-Verschraubung zwischen Handlaufpfosten und Stufe. Links oder rechts verwendbar.
Set de vissage entre pilier de main courante et la marche. Utilisable à gauche ou à droite.
Screwing set between pile from handrail to step. usable for left or right side

Art.	Code		CHF	Stk/pcs
LF 4200.002.4	4200.002.4	1	45.00	

Bestellung Commande Order

Kunde, Client, Customer: _____

Kom., Commission: _____

Händler, Distributeur, Dealer: _____



www.lamifix.ch

lamifix@lamifix.ch

Tel: +41 55 225 48 48

2023/25

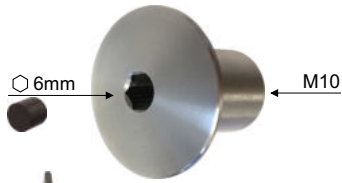

	Art. / Code				
Rundmutter M10, Inox A2	LF 3813.030.1	Ø 30	1	7.95	
Ecrous ronds M10, Inox A2	LF 3813.030.2		≥100	7.50	
Cap nuts M10, Inox A2			≥300	6.95	



Stockschraube M10, T25	LF 1570.060.1	60mm	10	4.30	
Vis à deux filetages M10, T25	LF 1570.060.2		100	41.00	
Hanger bolt M10, T25					



	LF 1570.080.1	80mm	10	4.75	
	LF 1570.080.2		100	45.00	

	LF 1570.100.1	100mm	10	5.50	
	LF 1570.100.2		100	52.50	

	LF 1570.120.1	120mm	10	6.90	
	LF 1570.120.2		100	65.50	

	LF 1570.140.1	140mm	10	8.50	
	LF 1570.140.2		100	80.50	

	LF 1570.160.1	160mm	10	10.50	
	LF 1570.160.2		100	99.00	

	LF 1570.180.1	180mm	10	12.00	
	LF 1570.180.2		100	115.00	

	LF 1570.200.1	200mm	10	13.50	
	LF 1570.200.2		100	128.50	

Betonschraube M10	LF 1572.075.1	M10 x 75mm	25	45.50	
Vis à béton	LF 1572.075.2		100	175.50	
Concrete screw					



	LF 1572.085.1	M10 x 85mm	25	46.50	
	LF 1572.085.2		100	179.50	

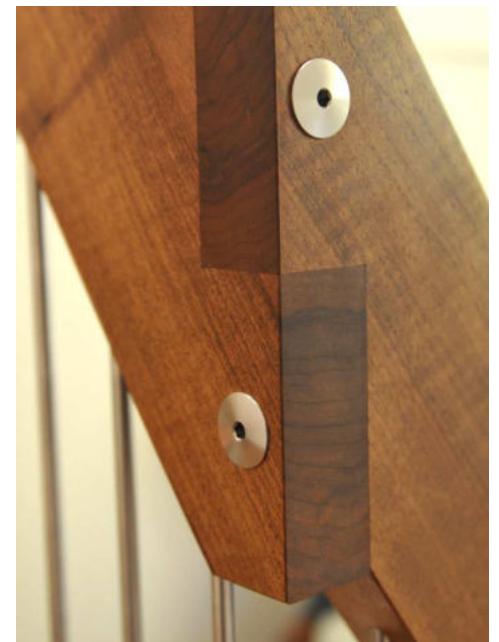

Bestellung Commande Order

Kunde, Client, Customer: _____

Kom., Commission: _____

Händler, Distributeur, Dealer: _____

www.lamifix.ch

















lamifix@lamifix.ch

Tel: +41 55 225 48 48

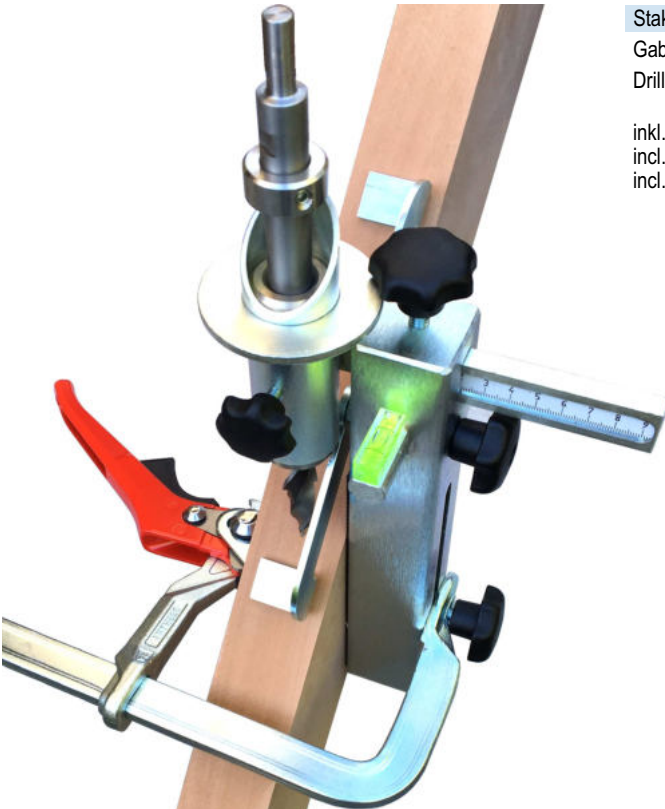

2023/25

Werkzeug für Stufenaufhängungen Outils pour suspension de marches Tools for step hangers

	Art. / Code						
	Stockschraubeneindreher Outil pour vis à deux filetages Hanger bolt driver	LF 1569.010.3	M10	1	45.50		
	Stufenbohrer Mèche étagée Stepped drill	LF 2051.003.3 → 1441.010 + 3805... + 3900...	Ø12/16	HS	1	148.00	
	Staketenbohrer Mèche pour barre Drill for bar	LF 2052.003.3 → 3905...	Ø 10	HM	1	85.00	
	Verlängerung für Bohrer Allongement pour mèche Extension piece for drill	LF 2055.150.3 → 2051.003 + 2052.003	Ø16x135		1	57.00	
	Eindrehwerkzeug Outil à visser Screw tool	LF 1442.011.3 → 1441.010	M10		1	99.50	
	Stirnlochschlüssel Clé à ergots pour rosaces Face spanner for bearings	LF 3807.025.3 → 3802.037 + 3803.037 + 3912.037			1	15.00	
	Staketenbohrlehre Gabarit de perçage pour suspension Drill jig for hanger	LF 3906.002.3			1	390.00	

inkl. Bohrbüchse 16mm. Weitere Grössen auf Anfrage erhältlich.
incl. canon de perçage 16mm. Autre dim. disponibles sur demande.
incl. drill guide 16mm. Other sizes available on request.

Bestellung Commande Order

Kunde, Client, Customer: _____

Kom., Commission: _____

Händler, Distributeur, Dealer: _____

www.lamifix.ch

lamifix@lamifix.ch

Tel: +41 55 225 48 48



2023/25



Koffer für den Treppenaufbau:
Für Werkstatt- und Montagearbeiten
20 Werkzeuge + 220 Sortimentsteile

Coffret de montage p. escaliers:
Pour travaux à l'atelier et au montage
20 outils et 220 éléments d'assortiment

Tool box for staircases:
For work in factory and mounting
20 tools and 220 assorted parts

Art. / Code

LF 3401.004.5



1



1'250.00

Bestellung
Commande
Order

6

Bestellung Commande Order

Kunde, Client, Customer: _____

Kom., Commission: _____

Händler, Distributeur, Dealer: _____



www.lamifix.ch

lamifix@lamifix.ch

Tel: +41 55 225 48 48

2023/25

Antirutschklebeband (Gummioberfläche)
Bande antidérapante (surface en gomme)
Anti - slip tape (rubber surface)



Art. / Code

LF 3925.001.1
Schwarz, Noir, Black

1.1 x 25 mm x 18.3 m



1



45.00

Bestellung
Commande
Order



LF 3925.002.1

Schwarz, Noir, Black

0.8 x 25 mm x 18.3 m

1

45.00



LF 3925.003.1

Transparent

1.0 x 25 mm x 18.3 m

1

45.00



Zentrumsschraube für Spindeltreppe
Vis centrale pour escalier en colimaçon
Center screw for spiral stairs



LF 3724.001.1

M24

1

1.90

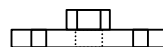

LF 3724.002.1

M24 / Ø 184 mm

1

65.00

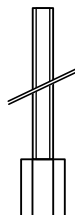

LF 3724.003.1

M24 x 1 m

1

49.00

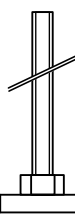

LF 3724.004.1

M24 x 1 m / Ø 184 mm

1

89.00



Sperrholzringe auf Anfrage erhältlich.
 Anneaux en contre-plaqué disponibles sur demande.
 Plywood sleeves available on request.

Bestellung Commande Order

Kunde, Client, Customer: _____

Kom., Commission: _____

Händler, Distributeur, Dealer: _____

www.lamifix.ch

lamifix@lamifix.ch

Tel: +41 55 225 48 48



2023/25

Handlaufstützen / Supports pour mains courantes / Supports for handrails

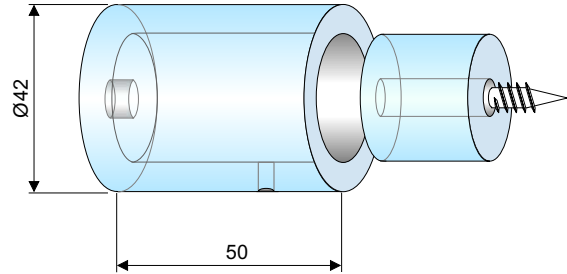

Art. / Code



Bestellung
Commande
Order

LF 4100.004.1	Inox A2	1	39.50	
---------------	---------	---	-------	--

LF 4100.004.2		≥10	37.50	
---------------	--	-----	-------	--

Inkl. Schrauben, incl. vis, incl. screws

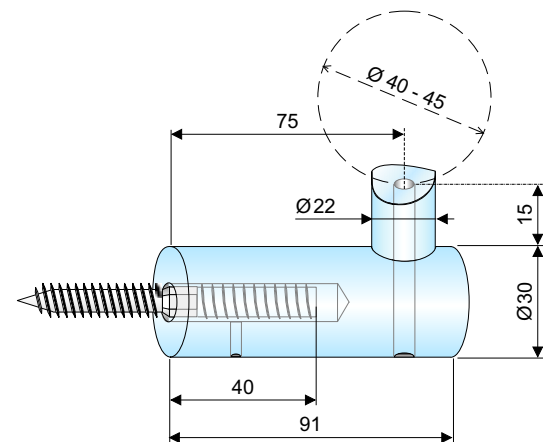

LF 4102.005.1	Inox A2	1	39.00	
---------------	---------	---	-------	--

LF 4102.005.2		≥10	37.00	
---------------	--	-----	-------	--

Inkl. Schrauben, incl. vis, incl. screws

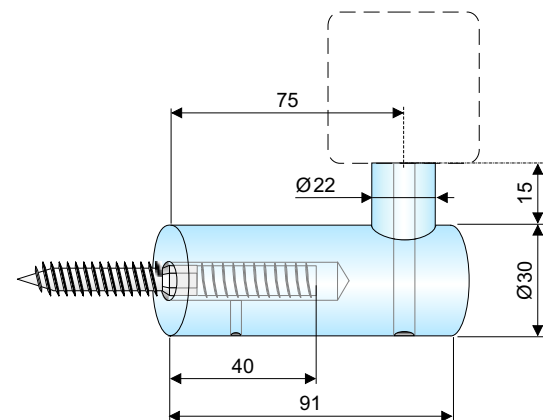

LF 4102.006.1	Inox A2	1	39.00	
---------------	---------	---	-------	--

LF 4102.006.2		≥10	37.00	
---------------	--	-----	-------	--

Inkl. Schrauben, incl. vis, incl. screws

Bestellung Commande Order

Kunde, Client, Customer: _____

Kom., Commission: _____

Händler, Distributeur, Dealer: _____

www.lamifix.ch

lamifix@lamifix.ch

Tel: +41 55 225 48 48



2023/25

Stufenaufdoppelung Doublage sur marche Step doubling

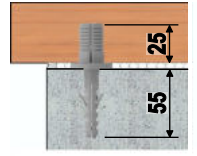
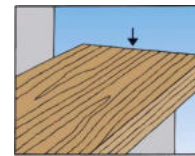
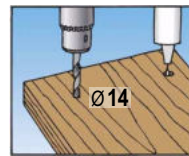
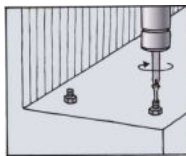
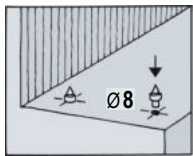

Art. / Code				
LF 1565.060.1	Ø 8 x 55	50	85.00	
LF 1565.061.1	Markierspitze Pointe de marquage Marking-tip	10	17.00	

Stufenabstützung und Spezialsituationen, auf Anfrage. Marche-pied et situations particulières, sur demande. Shore of steps and special situations, on request.



Bestellung Commande Order

Kunde, Client, Customer: _____

Kom., Commission: _____

Händler, Distributeur, Dealer: _____



www.lamifix.ch

lamifix@lamifix.ch

Tel: +41 55 225 48 48

2023/25

Art.	Code		1		
LF 35.M10x30 	1035.130.1	25	4.10	102.50	
	1035.130.2	200	3.98	796.00	
LF 1435.001 	1435.001.1	10		19.00	
	1435.001.2	≥100	1.75		
Abdeckkappe Inox-décor Capuchon, Cap					
LF 1436. . . .	Abdeckkappe, Capuchon, Cap				
	1436.004.1	Buche	1	5.50	
	1436.004.2	Hêtre, Beech	≥100	5.24	
	1436.009.1	Ahorn	1	5.50	
	1436.009.2	Érable, Maple	≥100	5.24	
	1436.010.1	Eiche	1	5.50	
	1436.010.2	Chêne, Oak	≥100	5.24	
	1436.005.1	Esche	1	5.50	
	1436.005.2	Frêne, Ash	≥100	5.24	
	1436.011.1	Europ. Kirsch.	1	5.50	
	1436.011.2	Cerisier, Cherry	≥100	5.24	
	1436.013.1	Europ. Nuss.	1	5.50	
	1436.013.2	Noyer, Walnut	≥100	5.24	
LF 1441. . . .	Gew-Muffe, Manchon à visser, Thread sleeve				
	Stahl verz., acier zingué, steel galv.				
	1441.010.1	M10,	25	26.00	
	1441.010.2	Ø12x23	100	99.00	
	1441.130.1	M10,	1	3.20	
	1441.130.2	Ø16x30	≥100	2.95	
	1441.160.1	M10,	1	4.50	
1441.160.2	Ø15x60	≥100	4.20		
LF 1442.011	1442.011.3	1		99.50	
Eindrehwerkzeug Outil à visser Screw tool → 1441.010					
LF 1455.010	1455.010.1	10		29.00	
	1455.010.2	≥100	2.80		
	Anschlag oben, Butée du haut, End stop top → 1571. . . . + 3805. . . .				
LF 1456. . . .	Kupplung, Accouplement, Coupling M10				
	1456.003.1	30 mm	10	12.00	
	1456.003.2		≥100	1.15	
	1456.010.1	40 mm	10	15.00	
	1456.010.2		≥100	1.45	
→ 1571. . . . + 1572. . . .					
LF 1456. . . .	Gewindestift + Kupplung verpresst				
Vis sans tête + Accouplement incl. pression					
Allen set screw + coupling incl. stamping					
	1456.083.1	L = 83	1	4.50	
	1456.083.2		≥100	4.40	
	1456.103.1	L = 103	1	6.30	
	1456.103.2		≥100	6.15	

Art.	Code				
LF 1458.010	1458.010.3	1	125.00		
Presswerkzeug inkl. Schlagbolzen Outil d'estampage incl. percuteur Stamping tool incl. hammer bolt → 1455.010 + 1456.010					
LF 1530.006	1530.006.1	100	12.50		
	3.9 x 45 Phosphatiert, Phosphaté				
	→ Set 2 / 6 Phosphated				
LF 1541.002	1541.002.1	100	39.00		
	5.5 x 32 mm				
	Inox A2				
LF 1541.003	1541.003.1	100	39.90		
	5.5 x 38 mm				
	Inox A2				
LF 1560.003	1560.003.1	100	29.00		
	6.3 x 32 mm				
	→ 1435.001 + 1436. . . .				
LF 1565.060	1565.060.1	50	85.00		
Stufenaufdoppelung, Doublage sur marche Step doubling, Ø 8 x 55					
LF 1565.061	1565.061.1	10	17.00		
	Markierspitze, Pointe de marquage				
	Marking-tip, → 1565.060				
LF 1569.010	1569.010.3	1	45.50		
Stockschraubeneindreher M10 Outil pour vis à deux filetages M10 Hanger bolt driver M10					
LF 1570. . . .	Stockschrauben M10, Vis avec deux filetages M10, Hanger bolt M10 → 3813.030				
	1570.060.1	60mm	10	4.30	
	1570.060.2		100	41.00	
	1570.080.1	80mm	10	4.75	
	1570.080.2		100	45.00	
	1570.100.1	100mm	10	5.50	
	1570.100.2		100	52.50	
	1570.120.1	120mm	10	6.90	
	1570.120.2		100	65.50	
	1570.140.1	140mm	10	8.50	
	1570.140.2		100	80.50	
	1570.160.1	160mm	10	10.50	
	1570.160.2		100	99.00	
	1570.180.1	180mm	10	12.00	
	1570.180.2		100	115.00	
	1570.200.1	200mm	10	13.50	
	1570.200.2		100	128.50	

Bestellung Commande Order

Kunde, Client, Customer: _____

Kom., Commission: _____

Händler, Distributeur, Dealer: _____



www.lamifix.ch

lamifix@lamifix.ch

Tel: +41 55 225 48 48

2023/25

Art.	Code		1		
LF 1571. . . .	Gewindestifte + Gewindestangen, Vis sans tête + tiges filetées				
	Allen set screw + threaded rods		→ 1455.010	+ 3806.130	
	1571.006.1	10	15.00		
	M10 x 60 mm				
	1571.008.1	10	21.00		
	M10 x 80 mm				
	1571.097.1	1	4.45		
	M10 x 1 m ± 1 cm				
	1571.197.1	1	6.90		
	M10 x 2 m ± 2 cm				
	1571.300.1	1	13.50		
	M10 x 3 m ± 3 cm				

LF 1572. . . .	Senkkopfschraube, Inox A2				
	Vis à tête fraisée, countersunk screw				
	1572.020.1	100	50.00		
	M10 x 20 mm				
	1572.025.1	100	55.00		
	M10 x 25 mm				

LF 1572. 0 . .	Betonschraube, Vis à béton, Concrete screw, M10				
	1572.075.1	25	45.50		
	M10 x 75 mm				
	1572.085.1	25	46.50		
	M10 x 85 mm				

LF 1620.016	1620.016.1	1	3.95		
	1620.016.2	≥100	3.50		
	Ø 16 / 25 x 76 mm, Schallschutzdübel				
	Cheville acoustique, Silencer dowel				

LF 1700.002	1700.002.1	1	3.90		
	M10, Ø 15 x 75 mm, Innengewindehülse				
	Stahl, Douille filetage intérieur acier				
	Steel anchor sleeve				

LF 1710.0 . .	Siebhülsen, Douilles de passoire, Screen tube				
	1710.020.1	1	1.50		
	Ø 20 x 88 mm	≥100	1.30		
	→Set 5				
	1710.021.1	1	1.90		
	Ø 20 x 130 mm	≥100	1.70		
	→Set 5 XXL				
	1710.032.1	1	3.55		
	Ø 32 x 108 mm	≥100	3.30		
	→Set 8				
	1710.033.1	1	3.95		
	Ø 32 x 128 mm	≥100	3.75		
	→Set 9				

LF 1720.002	1720.002.1	1	39.00		
	Verbundmörtel 300ml	≥5	37.50		
	Mortier chimique				
	Injection mortar				



F 120

Art.	Code			
LF 1801. . . .	Rosette, Rosace			
	1802.016.1	1	3.95	
	Inox A2	≥100	3.75	
	d1 = 16, h = 7 mm			
	→3616. . .			
	1801.025.1	10	19.00	
	Inox-décor	≥100	1.75	
	d1 = 25, h = 3.5 mm			
	→3601. . . / Set: 2 - 9			
LF 2001.250	2001.250.3	1	95.00	
	Bohrer mit Zentrierspitze, Mèche avec			
	pointe de centrage, Drill with center point			
	Ø 25 / 13 x 160 mm, HS, →2118.250			

LF 2011.380	2011.380.3	1	93.00	
	Ø 38 / 10 x 15 mm, HW			
	Bohrer, Mèche, Drill			
	→1435.001 + 1436. . .			

LF 2033.140	2033.140.3	1	15.20	
	Ø 13.5 / 10 x 130 mm, HS			
	Bohrer, Mèche, Drill			
	→3805. . .			

LF 2051.003	2051.003.3	1	148.00	
	Stufenbohrer HS, Mèche étagée HS			
	Stepped drill HS			
	→Set 11, 12, 13, 31, 32 + 3805. . .			

LF 2052.003	2052.003.3	1	85.00	
	Staketenbohrer Ø 10mm, HM			
	Pour barre, For bar			
	→3905. . .			

LF 2055.150	2055.150.3	1	57.00	
	Verlängerung 135 mm			
	Rallonge, Extension piece			
	→2051.003 + 2052.003			

LF 2060. . . .	Bohrer, HW, Quadro, SDS-Plus			
	Mèche, Drill			
	2060.160.3	1	45.00	
	Ø 16 mm			
	2060.200.3	1	49.00	
	Ø 20 mm			
	2060.250.3	1	62.00	
	Ø 25 mm			

LF 2070. . . .	Armierungsbohrer, Pour fer béton, Rebar cutter			
	HW, SDS-Plus			
	2070.200.3	1	99.00	
	Ø 20 mm			
	2070.250.3	1	115.00	
	Ø 25 mm			
	→Set 7			
	2070.320.3	1	125.00	
	Ø 32 mm, Für Ziegelstein, Pour briques, For bricks			
	→Set 8 + 9			

Bestellung Commande Order

Kunde, Client, Customer: _____

Kom., Commission: _____

Händler, Distributeur, Dealer: _____





www.lamifix.ch







lamifix@lamifix.ch

Tel: +41 55 225 48 48

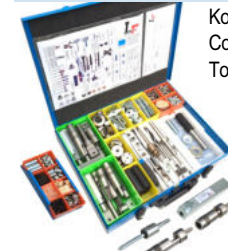

2023/25

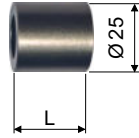
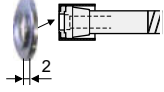
Art.	Code		1		
 LF 2115.040	2115.040.3	2		59.00	
Rosette zum Anschrauben der Bohrschablone Rosace pour visser le gabarit de perçage Screwing support for fixing drill jig					
 LF 2116.040	2116.040.3	1		46.00	
Führungshülse für Bohrbüchse Douille de guidage pour canon de perçage Guide bush for drill guide →2118... / 2119... + 2120...					
 LF 2117.040	2117.040.3	1		32.00	
Anschraubring Anneau à visser Screwing ring →2116.040					
 LF 2118.250	2118.250.3	1		40.00	
Bohrbüchse für Holzbohrer, Ø 25 mm Canon de perçage pour mèche pour bois Drill guide for wood drill →2001.250					
 LF 2119. ...	Bohrbüchse für Steinbohrer Canon de perçage pour mèche pour pierre, Drill guide for rock drill				
	2119.160.3 Ø 16 mm →2060.160	1		40.00	
	2119.200.3 Ø 20 mm →2060.200	1		40.00	
	2119.250.3 Ø 25 mm →2060.250	1		40.00	
 LF 2120. ...	Bohrbüchse für Armierungsbohrer, Canon de perçage pour fer béton, Drill guide for rebar cutter				
	2120.200.3 Ø 20mm →2070.200	1		40.00	
	2120.250.3 Ø 25mm →2070.250	1		40.00	
	2120.320.3 Ø 32mm →2070.320	1		40.00	
 LF 230.BIT	2150.030.3	1		42.00	
Bit →LF 30 + LF 35					
 LF 2150.036	2150.036.3	1		42.00	
Eindrehwerkzeug, Outil à visser Screw tool → Set 1, 2, 3624, det. A + B					
 LF 2151.036	2151.036.3	1		42.00	
Eindrehwerkzeug, Outil à visser Screw tool → Set 1, 2, 3624, det. C					

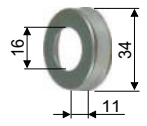
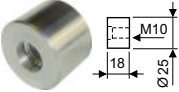
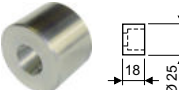
Art.	Code		1		
 LF 2198.001	2198.001.3	1		59.00	
Umschaltknarre, Zubehör 5-teilig Cliquet réversible avec 5 accessoires Reversible ratchet incl. 5 attachments					
 LF 2199.105	2199.105.3	1		275.00	
Nutfräser 7x25mm Fraises à rainurer Ø 105/30mm Cutter for grooving					
 LF 3401.004	3401.004.5	1		1'250.00	
Koffer für den Treppenbau Coffret de montage pour escaliers Tool box for staircases 					
 LF 3601. ...	Abdeckhülse Inox-décor Couvercle, Cover sleeve				
	3601.001.1 → LF 3623.102 L = 26mm	10 ≥100		19.00 1.75	
	3601.002.1 L = 18mm → LF 3623.102	10 ≥100		19.00 1.75	
 LF 3605.002	3605.002.1	10		28.00	
Justierscheibe für Distanz 18 - 24 mm Rondelle de réglage pour distance Adjusting shim for distance → 3623.102					
 LF 3616. ...	Rundstab, Inox A2, Ø 16 mm Barre ronde, Round bar				
	3616.150.1 L = 150mm	10		42.00	
	3616.180.1 L = 180mm	10		47.00	
	3616.210.1 L = 210mm → 3617.016 + 1802.016 + 1620.016	10		51.50	
 LF 3617.016	3617.016.1	10		15.00	
Topf zum Einschlagen Stahl Pot pour enfoncer, Pot to hammer in → 3616. ...					
 LF 3623.018	3623.018.1 3623.018.2	1 ≥100		4.95 4.50	
Distanzring Inox A2 Anneau de distance, Distance ring → 1700.002					
 LF 3624.018	3624.018.1 3624.018.2	1 ≥100		4.95 4.50	
Distanzring Inox A2, Anneau de distance, Distance ring → Set: 21 + 22					

Bestellung Commande Order

Kunde, Client, Customer: _____

Kom., Commission: _____

Händler, Distributeur, Dealer: _____



www.lamifix.ch

lamifix@lamifix.ch

Tel: +41 55 225 48 48

2023/25

Art.	Code			
------	------	--	--	--

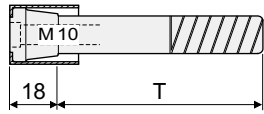

LF 3623.1 ..	Ø 25 / 16 mm, Anker Inox-décor			
3623.102.1	T 78mm Standard	1	9.20	
3623.102.2		≥100	8.65	
Ancre, Anchor → Set: 5, 6, 7, 8, 9, det. A+B				
3623.112.1	T 118mm XXL	1	11.75	
Ancre, Anchor → Set: 5 XXL, det. A+B				

LF 3623.202	Ø 25 / 16 mm, Anker, Ancre, Anchor, Inox A2			
--------------------	--	--	--	--

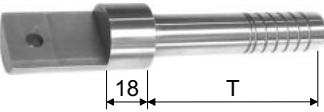

3623.202.1	T 78mm Standard	1	13.20	
3623.202.2		≥100	12.55	
→ Set: 5, 6, 7, 8, 9, det. C				
3623.212.1	T 127mm XXL	1	16.50	
→ Set: 5 XXL, det. C				

LF 3623.0 ..	Bolzen zum Eindrehen, Inox A2			
Boulon pour visser, Bolt to screw				

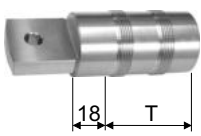

3623.035.1	T 35mm	1	11.00	
3623.035.2		≥100	10.50	
3623.050.1	T 50mm	1	12.25	
3623.050.2		≥100	11.75	
3623.065.1	T 65mm	1	13.35	
3623.065.2		≥100	12.85	
3623.080.1	T 80mm	1	14.45	
3623.080.2		≥100	13.95	

LF 3624.0 ..	Bolzen zum Eindrehen, Inox A2			
Boulon pour visser, Bolt to screw				



3624.030.1	T 30mm	1	10.90	
3624.030.2		≥100	10.40	
3624.038.1	T 38mm	1	10.95	
3624.038.2		≥100	10.45	

LF 3623.5 ..	Bolzen zum Eindrehen, Inox A2			
Boulon pour visser, Bolt to screw				

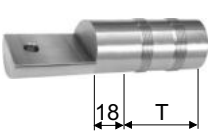

3623.535.1	T 35mm	1	11.00	
3623.535.2		≥100	10.50	
3623.550.1	T 50mm	1	12.25	
3623.550.2		≥100	11.75	
3623.565.1	T 65mm	1	13.35	
3623.565.2		≥100	12.85	
3623.580.1	T 80mm	1	14.45	
3623.580.2		≥100	13.95	

Art.	Code		1		
------	------	--	---	--	--

LF 3624.5 ..	Bolzen zum Eindrehen, Inox A2				
Boulon pour visser, Bolt to screw					
3624.530.1	T 30mm	1	10.90		
3624.530.2		≥100	10.40		
3624.538.1	T 38mm	1	10.95		
3624.538.2		≥100	10.45		



LF 3625.022	3625.022.1	1	12.95	
	3625.022.2	≥100	12.45	



Auflager Ø 25mm, Inox A2
Support, IG, M10
→ Set 21, 22, 50

LF 3625.001	3625.001.1	1	4.95	
--------------------	------------	---	------	--

Waxilit, Lubrifiant, Lub
→ Set 1, 2 + 3624



LF 3802.037	3802.037.1	1	9.85	
	3802.037.2	≥100	9.55	



Tragrossette M10, Ø 37mm, Inox A2
Rosace portante centre, Support bearing
→ 1571... + 3805...

LF 3803.037	3803.037.1	1	9.95	
	3803.037.2	≥100	9.65	



Endrossette M10, Ø 37mm, Inox A2
Rosace terminale, Bottom bearing
→ 1456... + 1571...

LF 3803.038	3803.038.1	1	9.95	
--------------------	------------	---	------	--



Endrossette zum Verlängern M10, Ø 37mm, Inox A2
Rosace terminale pour rallonge,
Extension bottom bearing
→ 1456... + 1571...

LF 3805. ...	Rohr geschliffen, Tube, Inox A2			
→ 1455.010 + 3802.037 + 3806.130 + 3811.030				



3805.097.1	1	6.95	
3805.097.2	≥100	6.45	
1 m ± 1 cm			
3805.197.1	1	13.90	
3805.197.2	≥50	12.90	
2 m ± 1 cm			
3805.600.1	1	41.70	
3805.600.2	≥20	38.70	
6 m ± 2 cm			

LF 3805.999	3805.999.3	1	2.40	
--------------------	------------	---	------	--

Zuschneiden der Rohre, Coupe
de tube, Cutting of tube → 3805.



Bestellung Commande Order

Kunde, Client, Customer: _____

Kom., Commission: _____

Händler, Distributeur, Dealer: _____



www.lamifix.ch

lamifix@lamifix.ch

Tel: +41 55 225 48 48

2023/25

Art.	Code			
LF 3806.001	3806.001.1 Höhenausgleich, Élément d'ajustage, Unterlay for levelling → 3805. . . + 3811.030	100	16.00	



LF 3806.130	3806.130.1 3806.130.2 Dämpfungshülse, Douille isolante, Silencer bush → 1456. . . + 1571. . .	10 100	7.50 72.00	
--------------------	---	-----------	---------------	--



LF 3806.160	3806.160.1 Dämpfungsring, Rondelle isolante Silencer ring → 1455.010 + 3802.037 + 3811.030	100	19.00	
--------------------	---	-----	-------	--



LF 3806.243	3806.243.1 Schraubensicherung mittelfest, Frein filet, Threadlocker, M2 - M36	1	7.95	
--------------------	--	---	------	--



LF 3807.025	3807.025.3 Stirnlochschlüssel für Rosetten Clé à ergots pour rosaces Face spanner for bearings → 3802.037 + 3803.037	1	15.00	
--------------------	--	---	-------	--



LF 3809.030	3809.030.1 3809.030.2 Zierrosette, Inox A2, Ø 30mm Rosace décorative → 3805. . .	1 ≥100	3.00 2.90	
--------------------	--	-----------	--------------	--



LF 3810.030	3810.030.1 3810.030.2 Deckenrosette Ø 30mm, Inox A2 Rosace de plafond, Ceiling rosette → 3805. . .	1 ≥100	3.00 2.90	
--------------------	--	-----------	--------------	--



LF 3811.030	3811.030.1 3811.030.2 Deck-Rosette Ø 31mm, Inox A2 Rosace du haut, Ring cover top → 3805. . .	1 ≥100	4.95 4.70	
--------------------	---	-----------	--------------	--



Art.	Code			
LF 3813.030	Rundmutter Ø 30 mm, M10, Inox A2 Ecrou rond, Cap-nut			
	3813.030.1	1	7.95	
	3813.030.2	≥100 ≥300	7.50 6.95	
	→ 1570. + 1571. + 1572.			



LF 3901.00. . .	Holz- / Douille en bois / Wood sleeve	Ø 16 / 10 x 25mm			
	3901.001.1	Buche	10	20.00	
	3901.001.2	Hêtre, Beech	≥100	1.90	
	3901.002.1	Ahorn	10	20.00	
	3901.002.2	Érable, Maple	≥100	1.90	
	3901.003.1	Eiche	10	20.00	
	3901.003.2	Chêne, Oak	≥100	1.90	
	3901.004.1	Esche	10	20.00	
	3901.004.2	Frêne, Ash	≥100	1.90	
	3901.005.1	Europ. Nuss.	10	20.00	
	3901.005.2	Noyer, Walnut	≥100	1.90	



LF 3902.020	3902.020.1 Ø 20 / 10 x 20mm Tanne, Sapin, Fir → Set 100	1	2.10	
--------------------	--	---	------	--



LF 3902.025	3902.025.1 Ø 25 / 16 x 20mm Tanne, Sapin, Fir → Set 101	1	2.20	
--------------------	--	---	------	--



LF 3905. . .	Stange geschliffen, Barre, Bar, Inox A2				
	→ Set 31, 32, 100 + 101				



3905.097.1	1	6.95	
3905.097.2	≥100	6.45	
1 m ± 1 cm			
3905.197.1	1	13.90	
3905.197.2	≥50	12.90	
2 m ± 1 cm			
3905.600.1	1	41.70	
3905.600.2	≥20	38.70	
6 m ± 2 cm			

LF 3905.997	3805.997.3	1	2.40	
	Zuschneiden der Stangen, Coupe de barre, Cutting of bar → 3905. . .			



Bestellung Commande Order

Kunde, Client, Customer: _____

Kom., Commission: _____

Händler, Distributeur, Dealer: _____

www.lamifix.ch

lamifix@lamifix.ch

Tel: +41 55 225 48 48



2023/25

Art.	Code			
LF 3906.002	3906.002.3	1	390.00	



Staketenbohrlehre
Gabarit de perçage pour souspension
Drill jig for hanger
→ 3805... + 3905...

LF 3911.031	3911.031.1	1	7.20	
-------------	------------	---	------	--



Deck-Rosette Ø 31mm, Inox A2
Rosace du haut M10
Ring cover top
→ Set 31 + 32

LF 3912.031	3912.031.1	1	8.50	
-------------	------------	---	------	--



Deck-Rosette Ø 31mm, Inox A2
Rosace du haut M16
Ring cover top
→ Set 32

LF 3912.037	3912.037.1	1	9.95	
-------------	------------	---	------	--



Trag-Rosette Ø 37mm, Inox A2
Rosace portante M16
Support bearing
→ Set 32

LF 3925.001	3925.001.1	1	45.00	
-------------	------------	---	-------	--



Antirutschklebeband
Bande antidérapante adhésive
Anti-slip tape
1.1 x 25mm x 18.3m

LF 3925.002	3925.002.1	1	45.00	
-------------	------------	---	-------	--



Antirutschklebeband
Bande antidérapante adhésive
Anti-slip tape
0.8 x 25mm x 18.3m

LF 3925.003	3925.003.1	1	45.00	
-------------	------------	---	-------	--



Antirutschklebeband, transparent
Bande antidérapante adhésive
Anti-slip tape
1.0 x 25mm x 18.3m

Art.	Code			
LF 4100.004	4100.004.1	1	39.50	



Ø 42x50mm, Inox A2 ≥10 37.50
Handlaufstütze, inkl. Schrauben
Support pour main courante, incl. vis
Support for handrails, incl. screws

LF 4102.005	4102.005.1	1	39.00	
-------------	------------	---	-------	--



Ø 30x91mm, Inox A2 ≥10 37.00
Handlaufstütze, inkl. Schrauben
Support pour main courante, incl. vis
Support for handrails, incl. screws
Ø 45 - 50mm

LF 4102.006	4102.006.1	1	39.00	
-------------	------------	---	-------	--



Ø 30x91mm, Inox A2 ≥10 37.00
Handlaufstütze, inkl. Schrauben
Support pour main courante, incl. vis
Support for handrails, incl. screws

LF 4200.002	4200.002.4	1	45.00	
-------------	------------	---	-------	--



Set für Pfostenverschraubung
Set pour visser le pilier
Set for pile screwing

LF 4150.450	4150.450.1	1	39.50	
-------------	------------	---	-------	--



Ø 45mm, M10
Glaspunkthalter, Inox A2
Porte-verre
Glass holder

LF 4150.451	4150.451.3	1	37.00	
-------------	------------	---	-------	--



Hakenschlüssel
Clé à ergot
Hook wrench

Weitere Artikel
sowie Fräs- und Drehteile auf Anfrage

Autres articles
pièces tournées et de fraisage sur demande

Other articles
turned and milled parts on request

LamiFIX AG

Janahof 7

CH-8722 Kaltbrunn

T: +41 55 225 48 48

E: lamifix@lamifix.ch